



woodworkers HARDWARE catalogue

woodworkers.com.au



ABN 84 010 877 675

sales@woodworkers.com.au

BRISBANE
1095 Ipswich Rd
Moorooka 4105
☎ 07 3848 1383
F: 07 3892 1476

GOLD COAST
Warehouse Road
Southport 4215
☎ 07 5571 0088
F: 07 5571 0617

SUNCOAST
53 Wisers Road
Maroochydore
☎ 07 5479 0999
F: 07 5479 0911

SYDNEY
2 Sydenham Rd
Brookvale 2100
☎ 02 9938 4999
F: 02 9938 4666

All products subject to change after publication. Refer our website www.woodworkers.com.au for current costings. All material copyrighted. Artwork in this catalogue may have been digitally altered and the actual product or colours may differ slightly.

door + window hardware specialists

Woodworkers designs and imports its own branded hardware specifically suited to solid timber joinery applications. We also source selected hardware items domestically where available to offer our customers the widest range of options specific to door and window applications. Because there is no middleman in the majority of hardware we offer, we can invest in premium finishes and materials. Our PVD finishes, for example, never tarnish and much of our stock is built around a stainless steel core instead of brass or diecast zinc for more durable long term performance. Our black hardware range is the largest available anywhere in Australia. Most importantly however, the hardware range we offer is tried and tested over many years to perform on timber joinery.

we design

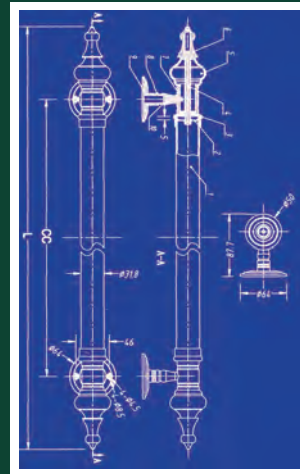

we produce



we import

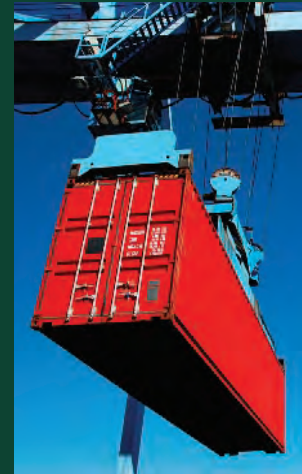

we simplify



LEGEND

- silver finishes
- gold finishes
- black finishes
- white finishes
- timber finishes
- antique finishes
- copper alloys
- polymer + plastic

refer pricelist for actual materials and specifications

we advise

we coordinate

and we deliver



PART 1

presentation pull handles

Woodworkers presentation door handle range is the largest and most innovative in Australia. We design and import products that we hope will stimulate your imagination. We continue to offer the widest range of materials and finishes that complement our industry leading range of fine timber doors to enable you to make your entrance highly individual.

SATIN SILVER HANDLES

WHAT'S THE DIFFERENCE BETWEEN 304 STAINLESS STEEL AND 316 MARINE GRADE?

316 Marine Grade has higher chromium content making it more resistant to discolouration. However all stainless steel can develop tea stain unless cleaned and waxed regularly. See FAQ 9 on our website for more information.

Crescent

■ 3033S
600mm

■ 3032S
450mm
also available
■ 3031S
300mm
while stock lasts



Offset Nova

■ 3088S
590mm

Front view Side view



Swerve

■ 3119S/L
508mm

■ 3119S/R
508mm

Front view Side view



silver is uniquely contemporary...

See our Helio Discounted Bundle Buy details on pg 13

■ 3052S
1500mm
back to back set only

■ 3049S
1200mm
back to back set only

■ 3045S
900mm
back to back set only

■ 3042S
600mm

■ 3039S
450mm

■ 3037S
300mm

also available

■ 3054S
1800mm
back to back set only

■ 3056S
2000mm
back to back set only

The Helio Range

Helio handles also available in 316 marine grade SS

■ 3041S 450mm ■ 3043S 600mm ■ 3047S 900mm

■ 3023S
1200mm
back to back set only

■ 3022S
560mm
back to back set only

■ 3021S
410mm
back to back set only



Cirque

■ 3068S
250mm

see our roller locks selection suitable for use with presentation pull handles.



Hip

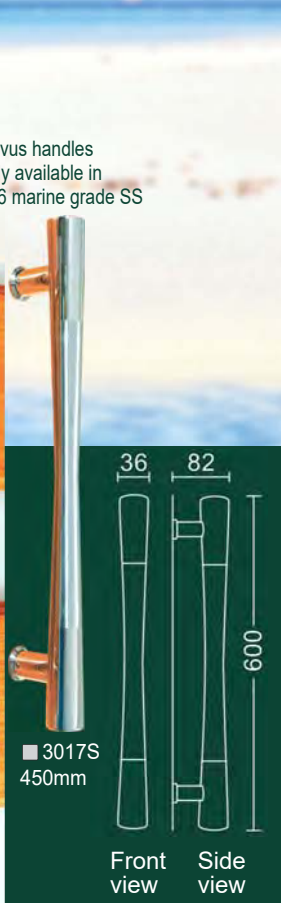
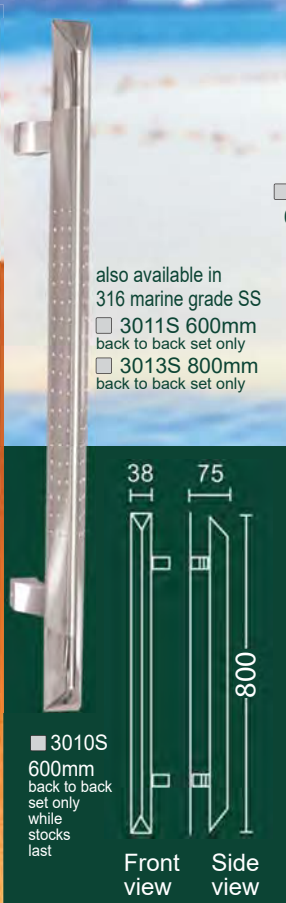
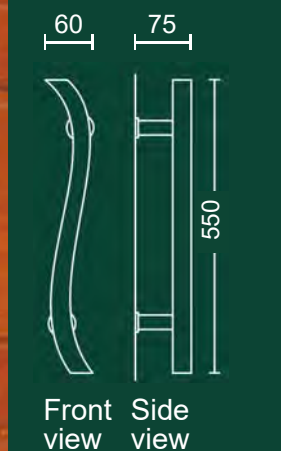
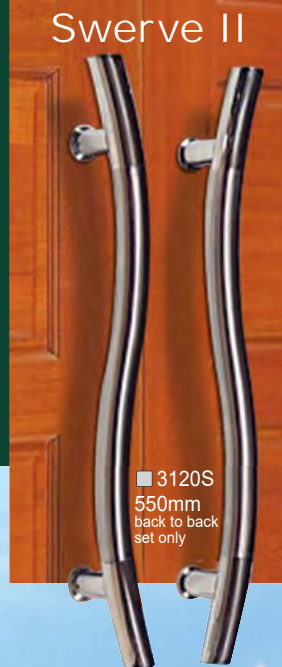
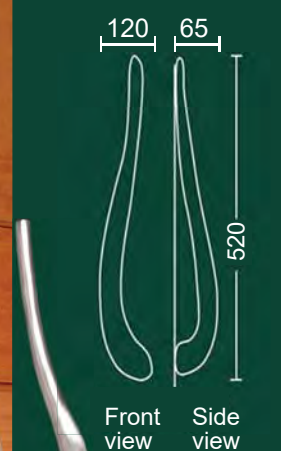
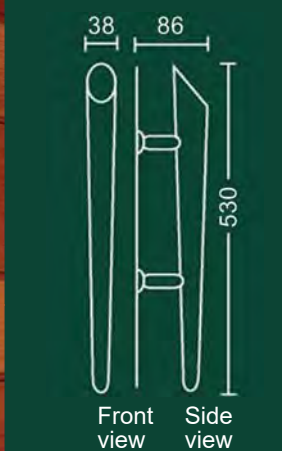
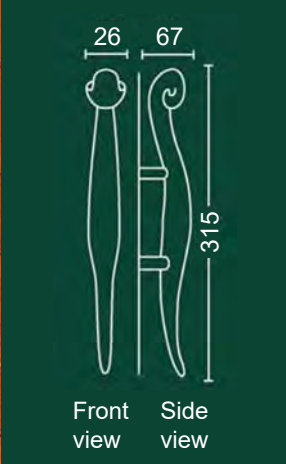

Sizzle



■ 3102S/L
545mm

■ 3102S/R
545mm

Domino

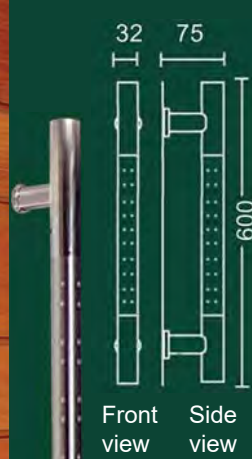

■ 3034S
450mm

■ 3035S
600mm

Granada

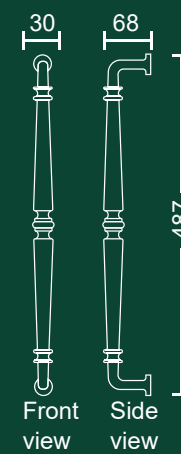

■ 3146S
487mm

Czar Silver

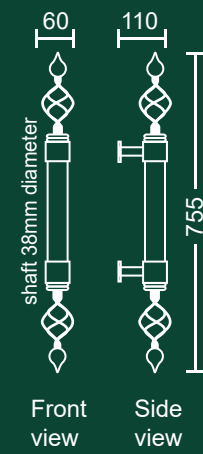

■ 3144S
755mm

see our roller locks selection
suitable for use with
presentation pull handles.

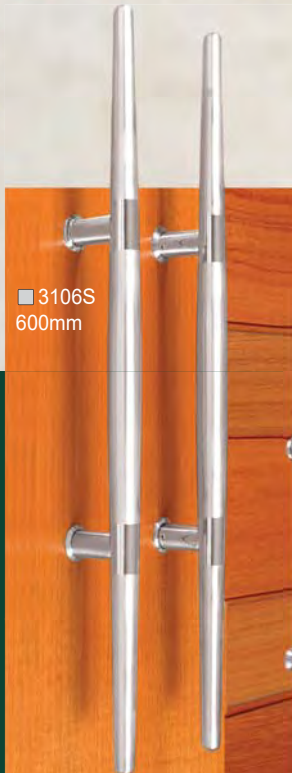

■ 3106S
600mm

Skittle

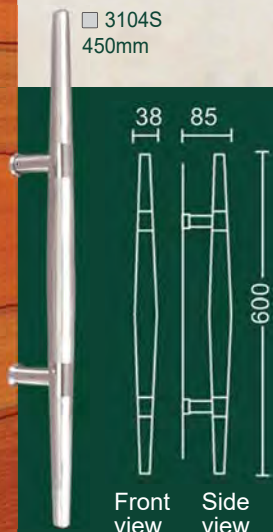

□ 3104S
450mm



Aqua Jazz

□ 3006S/R
540mm right handed
back to back set only
□ 3006S/L
540mm left handed
back to back set only



■ 3074S
450mm

Koji



Granada on Plate



□ 3147S
380mm

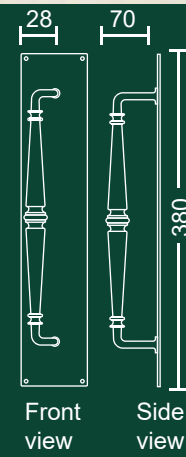

CUSTOM TIMBER HANDLES



■ 823S
cottage lever on
traditional plate euro

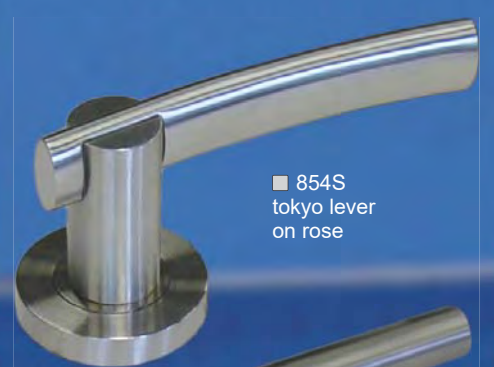

■ 854S
tokyo lever
on rose



■ 845S
nida lever
on rose



■ 827S
cottage lever on
slimline plate euro

THIS LEVER SUPPLIED IN
SILVER PREPACKAGED KITS



■ 829S
heritage lever
on plate euro



■ 833S
soho lever
on rose



■ 826S
cottage lever
on rose



■ 844S
milan lever
on rose



■ 834S
berlin lever on
square plate



■ 832S
zip lever
on rose



■ 831ST
clipper lever
on rose



■ 3131TS
timber carillon

pancake

domed

convex
stainless steel
43mm cap
options

■ 3128TS
full height
pole + caps

■ 3130TS
half round
grip

■ 3129T
full height
block grip

■ 3127T
full height
long grip



Got ideas?
We can make
almost any
timber handle
design

Woodworkers custom manufacture timber handles to achieve various architectural effects in red cedar, rosewood, Vic. Ash or other woods on request using computer controlled CNC machining. Custom handles are fabricated for each specific application and can be moulded to an infinite variety of design options. POA



pivot
door
with
custom
timber
handle

GOLD HANDLES

Amman



■ 3002G/L
520mm
left handed

■ 3002G/R
520mm
right handed



■ 3001G/R
315mm
right handed
■ 3001G/L
315mm
left handed

Koji



■ 3074G
450mm
back to back set only



Sizzle



■ 3102G/L
545mm
left handed

■ 3102G/R
545mm
right handed

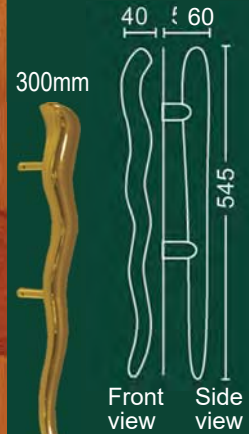

■ 3101G/R
300mm
right handed
■ 3101G/L
300mm
left handed

gold emanates prestige

see our roller locks selection suitable for use with presentation pull handles.

Woodworkers PVD gold pull handles have a stainless steel core finished in the most durable of all finishes with a lifetime warranty not to tarnish



■ 823G
cottage lever on
traditional plate euro



■ 827G
cottage lever
on slimline plate euro



■ 829G
heritage lever
on plate euro

THIS LEVER SUPPLIED IN GOLD PREPACKAGED KITS



■ 826G
cottage lever
on rose

■ 830G
heritage lever
on plate passage



■ 3028G
600mm

Connaught



■ 3027G
450mm



■ 3025G
460mm

Classic

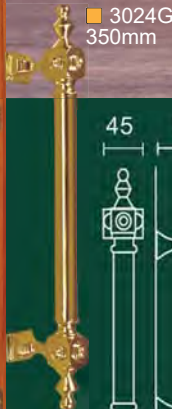

■ 3024G
350mm

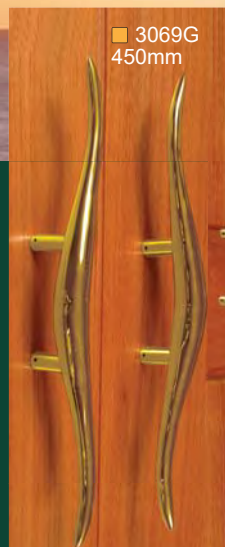

■ 3069G
450mm

Hip

■ 3068G
250mm



COPPER + PATINA HANDLES



■ 3006C/L
540mm
left handed
back to back
set only

■ 3006C/R
540mm
right handed
back to back
set only

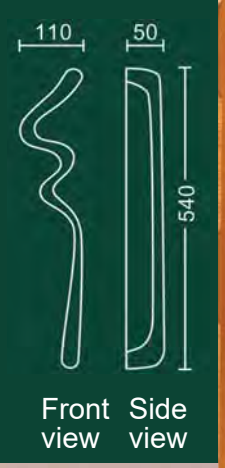

■ 3123C/L
450mm
left handed
back to back
set only

■ 3123C/R
450mm
right handed
back to back
set only

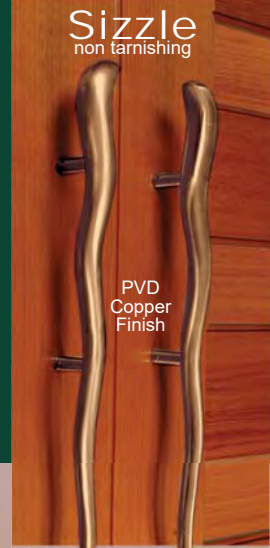
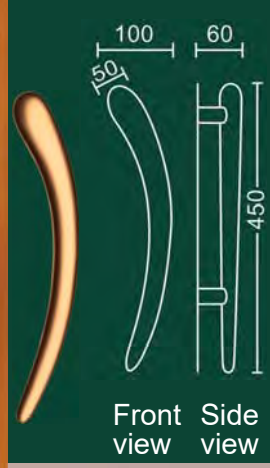

■ 3102C/L
545mm
left handed

■ 3102C/R
545mm
right handed

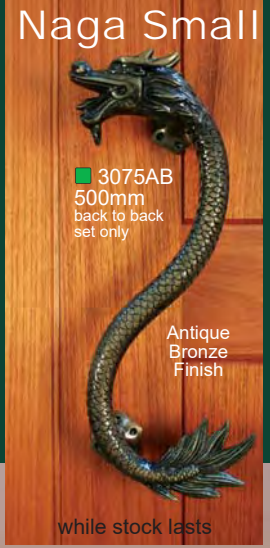
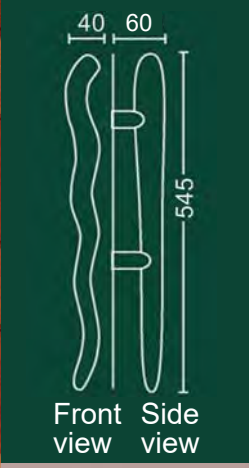

Woodworkers contemporary copper range have a stainless steel core finished in copper PVD - the most durable of all finishes with a lifetime warranty not to tarnish

copper ages to a gentle patina

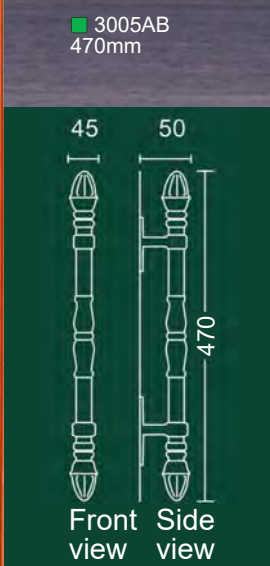
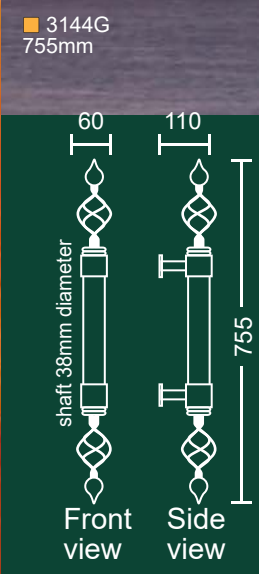

see our roller locks selection suitable for use with presentation pull handles.

BLACK HANDLES



■ 3071AS 370mm antique silver
 ■ 3071R 370mm rusty

Ironbridge



■ 3071B 370mm

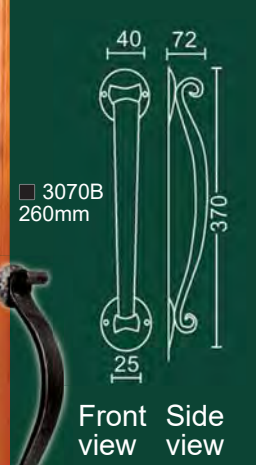

Triffid

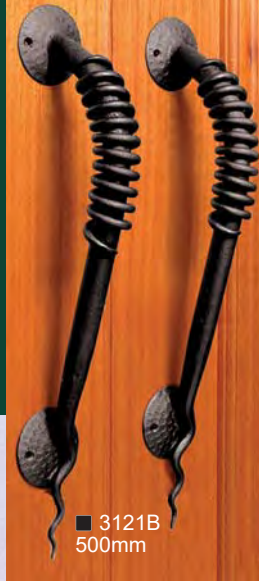

■ 3121B 500mm

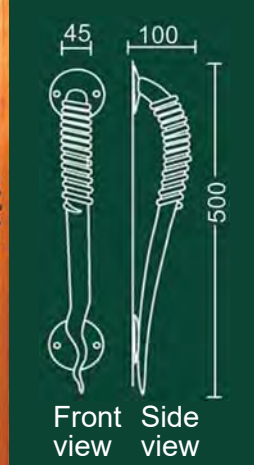

see our roller locks selection suitable for use with presentation pull handles.

Andalucia



■ 3004B 470mm

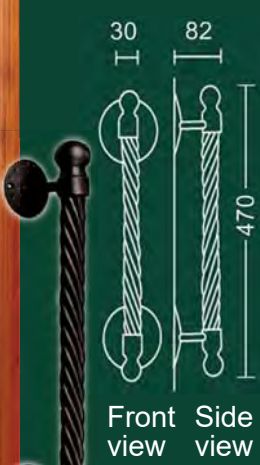

■ 3003B 325mm

Czar Black



also available

■ 3070AS 260mm ■ 3070R 260mm



handforged iron is bold + evocative

■ 3126G 420mm ■ 3126AC 420mm ■ 3126AB 420mm



polished brass antique copper antique brass

Bayou



■ 3125B 420mm

Boa

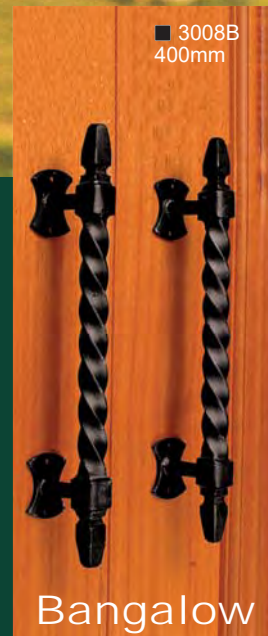
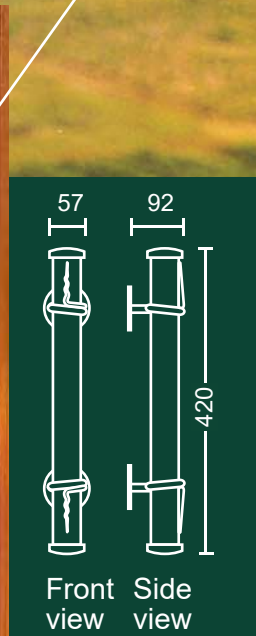

■ 3008B 400mm

Bangalow



■ 3007B 300mm



■ 3091B 400mm while stocks last

Rope

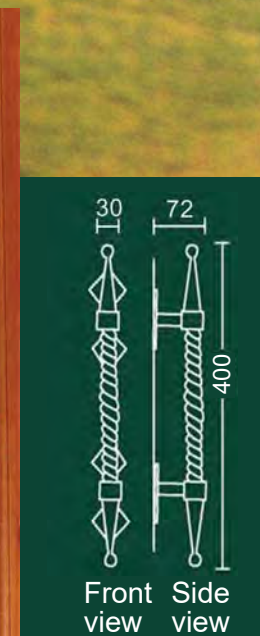

■ 3124AS 450mm ■ 3124B 450mm

antique silver matt black

Cadiz

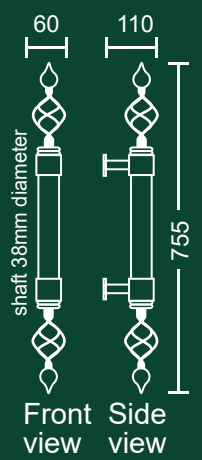

Front view Side view

■ 3144B
755mm

Black Cavus

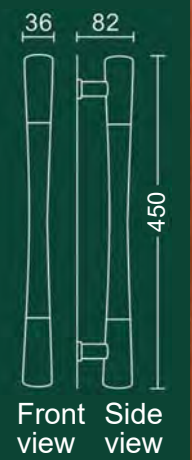
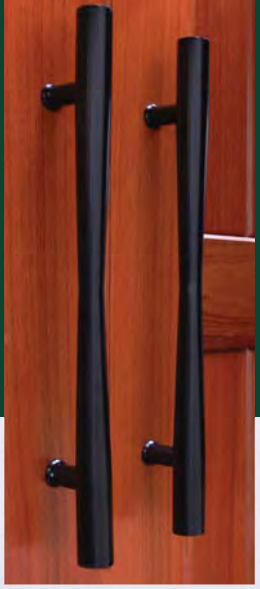

Front view Side view

■ 3016B
450mm
back to back
set only

Black Neo



Front view Side view

■ 3080B
600mm
back to back
set only

■ 823B
cottage lever
on traditional
plate euro

THIS LEVER SUPPLIED IN
BLACK PREPACKAGED KITS

■ 829B
heritage lever
on plate euro

■ 834B
berlin lever
on square

■ 850B
florence lever
on plate euro

■ 835B
chateau lever
on plate euro

■ 841B
baltimore lever
on plate euro

■ 838B
provence lever
on plate euro



Black Helio

■ 3042B
600mm
back to back
set only

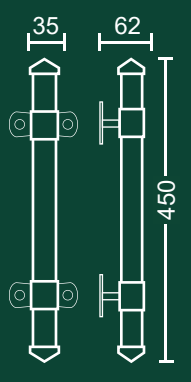

Front view Side view

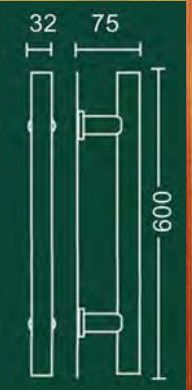

Front view Side view

■ 3147B
380mm



Granada
on Plate

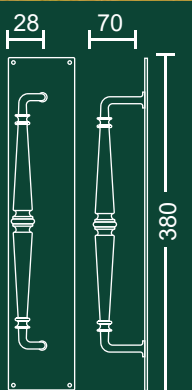

Front view Side view



Granada

■ 3146B
487mm

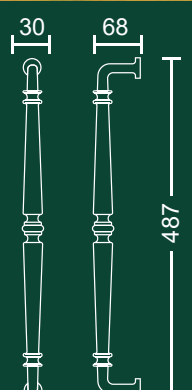

Front view Side view

woodworkers standard door hardware kits

PART 2 hardware kits



Woodworkers hardware kits make hardware selection simple and economical. All the components required are in a simple kit which can be easily supplied keyed alike for convenience. All kits contain proven high quality hardware specifically engineered for our timber joinery that are bulk packaged to reduce costs.



NOTE: HINGES ARE NOT INCLUDED IN STOCK KITS

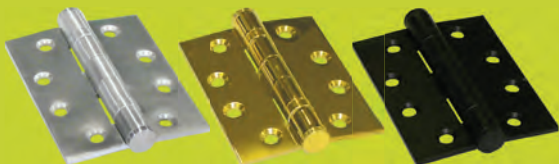

All butt hinges ballbearing stainless construction
PRICE PER HINGE
refer to item code in current hardware pricelist for costings

HINGE OPTIONS	silver	gold	black
BUTT HINGES			
item	code per single hinge		
100 x 60	401S	401G	NA
100 x 75	402S	402G	402B
100 x 100	403S	403G	403B
100 x 125	404S	404G	NA
100 x 150	405S	405G	NA
100 x 200	406S	406G	NA
HIRLINE HINGES			
100mm	411S	411G	411B
LIFT OFF HINGES			
100 x 75	421S/R	NA	NA
100 x 75	421S/L	NA	NA

DOUBLE ENTRY ROLLER KIT

DOUBLE ENTRY ROLLER KIT

2. Euro double cylinder
3. Signature keyed flush bolt 190mm
4. Signature non-keyed flush bolt 190mm
12. Escutcheon pair
13. Magnetic door stop - floor x 2
27. Mortice lock roller rebated

DOUBLE ENTRY ROLLER KIT - SILVER

4022S KIT DESIGNED TO BE USED WITH PRESENTATION PULL HANDLES

DOUBLE ENTRY ROLLER KIT - GOLD

4022G KIT DESIGNED TO BE USED WITH PRESENTATION PULL HANDLES

DOUBLE ENTRY ROLLER KIT - BLACK

4022B KIT DESIGNED TO BE USED WITH PRESENTATION PULL HANDLES

SINGLE ENTRY ROLLER KITS

SINGLE ENTRY ROLLER KIT

2. Euro cylinder
10. Roller lock 60mm
12. Escutcheon pair
13. Magnetic stop

ROLLER KIT

SINGLE ENTRY ROLLER KIT - SILVER

4021S KIT DESIGNED TO BE USED WITH PRESENTATION PULL HANDLES

SINGLE ENTRY ROLLER KIT - GOLD

4021G KIT DESIGNED TO BE USED WITH PRESENTATION PULL HANDLES

SINGLE ENTRY ROLLER KIT - BLACK

4021B KIT DESIGNED TO BE USED WITH PRESENTATION PULL HANDLES

PIVOT DOOR KIT

PIVOT DOOR KITS

2. Euro double cylinder
10. Roller lock 60mm
12. Escutcheon pair
13. Magnetic stop
15. Extended strike
16. Deadbolt mortice lock

PIVOT DOOR BOLT KIT - SILVER

4023S KIT DESIGNED TO BE USED WITH PRESENTATION PULL HANDLES

PIVOT DOOR BOLT KIT - GOLD

4023G KIT DESIGNED TO BE USED WITH PRESENTATION PULL HANDLES

PIVOT DOOR BOLT KIT - BLACK

4023B KIT DESIGNED TO BE USED WITH PRESENTATION PULL HANDLES

PIVOT DOOR ROLLER KIT - SILVER

4024S KIT DESIGNED TO BE USED WITH PRESENTATION PULL HANDLES

PIVOT DOOR ROLLER KIT - GOLD

4024G KIT DESIGNED TO BE USED WITH PRESENTATION PULL HANDLES

PIVOT DOOR ROLLER KIT - BLACK

4024B KIT DESIGNED TO BE USED WITH PRESENTATION PULL HANDLES

woodworkers standard door hardware kits

SINGLE ENTRY KIT

SINGLE ENTRY KIT

LEVER KIT

1. Euro lever handle set
2. Euro cylinder
6. Mortice lock 48cc
13. Magnetic stop

SINGLE ENTRY LEVER KIT - SILVER

■ 4002S

SINGLE ENTRY LEVER KIT - GOLD

■ 4002G

SINGLE ENTRY LEVER KIT - BLACK

■ 4002B

MULTIFOLD 1 WAY KIT

MULTIFOLD 1 WAY KIT

1. Euro lever handle set
2. Euro double cylinder
6. Mortice lock 48cc
9. Extended strike
14. Magnetic door stop - Wall

1 WAY KIT - SILVER

■ 4011S

1 WAY KIT - GOLD

■ 4011G

1 WAY KIT - BLACK

■ 4011B

FRENCH DOOR KIT

FRENCH DOOR KIT

1. Euro lever handle set
2. Euro double cylinder C4 65mm
3. Signature keyed flush bolt 190mm
4. Signature non-keyed flush bolt 190mm
5. Silent pattern cabin hook 150mm x 2
28. Mortice lock rebated 48cc

FRENCH DOOR KIT - SILVER

■ 4000S - open out
■ 4001S - open in

FRENCH DOOR KIT - GOLD

■ 4000G - open out
■ 4001G - open in

FRENCH DOOR KIT - BLACK

■ 4000B - open out
■ 4001B - open in

MULTIFOLD REBATED KIT

MULTIFOLD REBATED KIT

1. Euro lever handle set
2. Euro double cylinder
14. Magnetic door stop x 2 - Wall
28. Mortice lock rebated 48cc

REBATED KIT - SILVER

■ 4012S

REBATED KIT - GOLD

■ 4012G

REBATED KIT - BLACK

■ 4012B

INTERNAL PASSAGE + PRIVACY KIT

INTERNAL PASSAGE + PRIVACY KIT

1. Passage lever handle set
11. Privacy snib & bolt
17. Tube latch

watch our website videos on how to fit our locks

INTERNAL PRIVACY KIT - SILVER

■ 4004S

INTERNAL PRIVACY KIT - GOLD

■ 4004G

INTERNAL PRIVACY KIT - BLACK

■ 4004B

INTERNAL PASSAGE KIT - SILVER

■ 4003S

INTERNAL PASSAGE KIT - GOLD

■ 4003G

INTERNAL PASSAGE KIT - BLACK

■ 4003B

VERANDAH GATE SINGLE

CONTEMPORARY 1 GATE KIT

1. Euro lever handle set
2. Euro double cylinder
5. Silent pattern cabin hook 150mm
6. Mortice lock

SINGLE KIT - SILVER

■ 4081S

VERANDAH GATE PAIR

CONTEMPORARY 2 GATE KIT

1. Euro lever handle set
2. Euro double cylinder
5. Silent pattern cabin hook x 2
23. Panic bolt
28. Mortice lock rebated 48cc

DOUBLE KIT - SILVER

■ 4082S

SINGLE KIT - BLACK

■ 4081B

SINGLE KIT - GOLD

■ 4081G

DOUBLE KIT - BLACK

■ 4082B

DOUBLE KIT - GOLD

■ 4082G

door hardware kits

woodworkers door hardware kits

entry kit

door hardware kits

SLIDING DOOR KIT - OX



SLIDING DOOR KIT - OX - SILVER

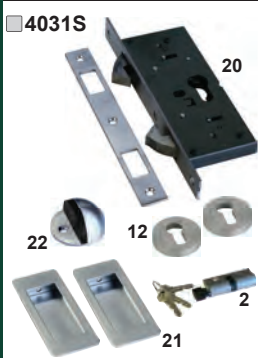

SLIDING DOOR KIT - OX - GOLD

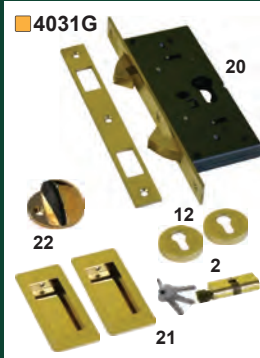

SLIDING DOOR KIT - OX - BLACK



SECURITY DOUBLE DOOR KIT

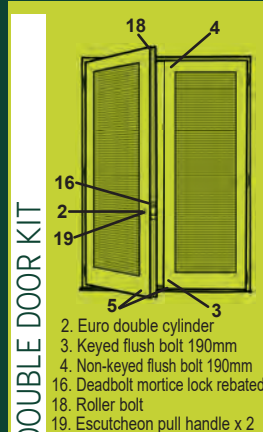

SECURITY DOUBLE DOOR KIT - SILVER



SECURITY DOUBLE DOOR KIT - GOLD



SECURITY DOUBLE DOOR KIT - BLACK



SLIDING REBATED DOORS OXOX



SLIDING REBATED DOORS OXOX - SILVER

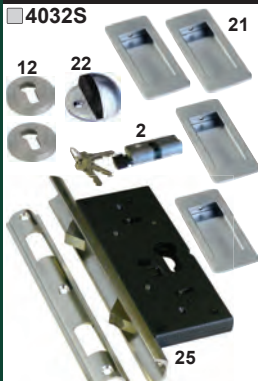

SLIDING REBATED DOORS OXOX - GOLD



SLIDING REBATED DOORS OXOX - BLACK



SECURITY DOUBLE DOOR KIT

get a 33% discount on morticing locks + flush bolts when you buy our Kits



TRADITIONAL VERANDAH GATE

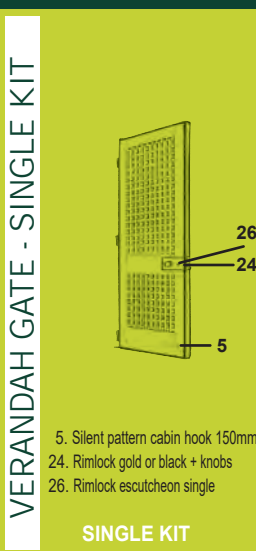

SINGLE KIT - POLISHED BRASS



SINGLE KIT - POLISHED BRASS/BLACK



SINGLE KIT - BLACK



TRADITIONAL VERANDAH GATE

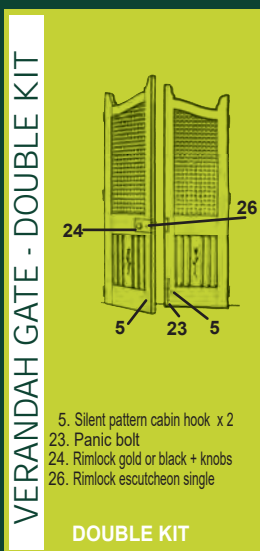

DOUBLE KIT - POLISHED BRASS



DOUBLE KIT - POLISHED BRASS/BLACK



DOUBLE KIT - BLACK



SECURITY SINGLE DOOR KIT

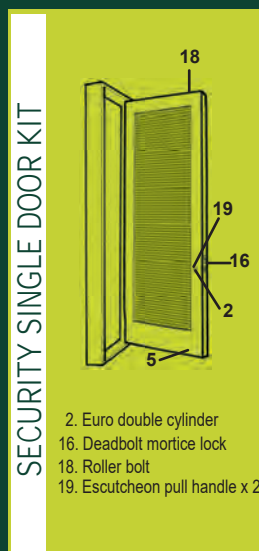

SECURITY SINGLE DOOR KIT - SILVER



SECURITY SINGLE DOOR KIT - GOLD

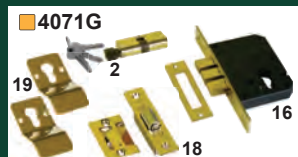

SECURITY SINGLE DOOR KIT - BLACK



TAKE 1 PAIR OF HELIO 600 + 304 STAINLESS STEEL HANDLES

OR FOR DOUBLE ENTRY KITS TAKE TWO PAIR OF HELIO'S FOR AN EXTRA \$100

you'll save a bundle when you buy our bundles

HELIO 600mm 304 STAINLESS STEEL HANDLES

Special bundle buys

alternative kits using different lever handle styles chosen from column A

PRICE CODE
3
PRICE CODE

berlin

PRICE CODE
2
PRICE CODE

soho

cottage on traditional black

nida

cottage on traditional gold

berlin

zip

tokyo

PRICE CODE
1
PRICE CODE

milan

cottage on rose

heritage on plate

clipper

SINGLE ENTRY LEVER KIT

1. Euro lever handle set
2. Euro double cylinder
8. Mortice lock
12. Escutcheon pair
13. Magnetic stop floor

FRENCH DOOR / DOUBLE ENTRY LEVER KITS

1. Euro lever handle set
2. Euro double cylinder
3. Keyed flush bolt 190mm
4. Non-keyed flush bolt 190mm
7. Mortice rebated latch lock
12. Escutcheon pair
13. Magnetic stop floor x 2

INTERNAL PASSAGE + PRIVACY KIT

1. Passage lever handle set
11. Privacy snib & bolt
17. Tube latch

INTERNAL PASSAGE KIT - SILVER

1. Passage lever handle set
11. Privacy snib & bolt
17. Tube latch

INTERNAL PASSAGE KIT - SILVER

1. Passage lever handle set
11. Privacy snib & bolt
17. Tube latch

INTERNAL PASSAGE KIT - SILVER

1. Passage lever handle set
11. Privacy snib & bolt
17. Tube latch

INTERNAL PASSAGE KIT - SILVER

1. Passage lever handle set
11. Privacy snib & bolt
17. Tube latch

INTERNAL PASSAGE KIT - SILVER

1. Passage lever handle set
11. Privacy snib & bolt
17. Tube latch

INTERNAL PASSAGE KIT - SILVER

1. Passage lever handle set
11. Privacy snib & bolt
17. Tube latch

INTERNAL PASSAGE KIT - SILVER

1. Passage lever handle set
11. Privacy snib & bolt
17. Tube latch

MULTIFOLD 1 WAY KIT

1. Euro lever handle set
2. Euro double cylinder
8. Mortice lock
12. Escutcheon pair
14. Magnetic door stop - Wall
15. Extended strike

MULTIFOLD REBATED KIT

1. Euro lever handle set
2. Euro double cylinder
7. Mortice lock rebated
12. Escutcheon pair
14. Magnetic stop x 2 - Wall

VERANDAH GATE PAIR

1. Euro lever handle set
2. Euro double cylinder
5. Cabin hook 150mm x 2
7. Mortice lock rebated
12. Escutcheon pair
23. Panic bolt

VERANDAH GATE SINGLE

1. Euro lever handle set
2. Euro double cylinder
5. Cabin hook 150mm
8. Mortice latch lock
12. Escutcheon pair

VERANDAH GATE PAIR

1. Euro lever handle set
2. Euro double cylinder
5. Cabin hook 150mm x 2
7. Mortice lock rebated
12. Escutcheon pair
23. Panic bolt

VERANDAH GATE SINGLE

1. Euro lever handle set
2. Euro double cylinder
5. Cabin hook 150mm
8. Mortice latch lock
12. Escutcheon pair

VERANDAH GATE PAIR

1. Euro lever handle set
2. Euro double cylinder
5. Cabin hook 150mm x 2
7. Mortice lock rebated
12. Escutcheon pair
23. Panic bolt

VERANDAH GATE SINGLE

1. Euro lever handle set
2. Euro double cylinder
5. Cabin hook 150mm
8. Mortice latch lock
12. Escutcheon pair

VERANDAH GATE PAIR

1. Euro lever handle set
2. Euro double cylinder
5. Cabin hook 150mm x 2
7. Mortice lock rebated
12. Escutcheon pair
23. Panic bolt

VERANDAH GATE SINGLE

1. Euro lever handle set
2. Euro double cylinder
5. Cabin hook 150mm
8. Mortice latch lock
12. Escutcheon pair

MORTICE LOCKS:

lock pocket

face plate recess

MORTICE LOCKS:

lock pocket

face plate recess

MORTICE LOCKS:

lock pocket

face plate recess

MORTICE LOCKS:

lock pocket

face plate recess

MORTICE LOCKS:

lock pocket

face plate recess

MORTICE LOCKS:

lock pocket

face plate recess

MORTICE LOCKS:

lock pocket

face plate recess

MORTICE LOCKS:

lock pocket

face plate recess

MORTICE LOCKS:

lock pocket

face plate recess

MORTICE LOCKS:

lock pocket

face plate recess

Woodworkers provide a service to machine out lock pockets and flush bolt routings to suit our hardware only. Price does not include installation of the hardware but does cover the trenching for the lock body and plate as shown but NOT for the striker plate, cylinder or spindle holes which need to be done on site by others. This permits flexibility for both single and double sided hardware to be fitted on site to suit the application. When Woodworkers hardware is ordered a discount applies to the morticing as a package

FLUSH BOLTS:

keyed bolt recess

slide recess

flush plate recess

FLUSH BOLTS:

keyed bolt recess

slide recess

flush plate recess

FLUSH BOLTS:

keyed bolt recess

slide recess

flush plate recess

FLUSH BOLTS:

keyed bolt recess

slide recess

flush plate recess

FLUSH BOLTS:

keyed bolt recess

slide recess

flush plate recess



door lock preparation & installation video

woodworkers door lock guide



ROLLER LOCKS

Roller locks restrain a door with a spring mounted roller shaped latch rather than a conventional wedge type latch that requires mechanical retraction. This allows the use of presentation pull handles (as no knob or lever is required) giving a contemporary uncluttered look. Like other locks there is an independent dead bolt to totally lock the door when required. Roller locks are available only with euro cylinder mechanisms and can be used in rebated door or single door applications.



SKELETON KEY LOCKS

These can be 5 Lever High Security Locks, to be used on external doors, or 3 Lever Low Security Locks to be used on internal doors. The difference between 5 Lever and 3 Lever Locks is the number of different key combinations available. These locks are supplied with a "skeleton" key. The main difference is that the 3 and 5 Lever Locks are more "traditional" for period homes but they cannot be master keyed.



TUBE LATCHES

This is used when the door doesn't need to be locked. It can be used with any type of lever or knob door furniture. Latch simply means you need a Tube Latch to make your door furniture functional.

PRIVACY LATCH

These latches can be used on Bedroom or Bathroom Doors. They have a thumb turn on one side and a safety release on the other side of the tubelatch.



EURO LATCH LOCKS

These are high security locks used on external doors suitable for modern euro cylinders. You can choose either a double-ended cylinder (where a key can be used from either end) or a thumb-turn cylinder (key for outside, thumb turn inside). They are morticed into the door stile so the lock mechanism is concealed from view. Euro cylinders can be masterkeyed as necessary to allow different access levels.



RIM LOCKS

These are low security locks that screw to the outer surface of the door (as opposed to a mortice lock, which is "morticed" into the door). Rim Locks require knobs with a threaded spindle, where the knob screws onto the threaded spindle and is secured by grub screws. Rim Locks are suitable for inward opening doors only and are not suitable for rebated doors. They are also known as carpenter's locks.



CYLINDER LOCKS

Quick fit cylinder locks integrate the handle and lock into a single unit that can be master keyed and is easily fitted with only two drilled holes being required. They are available with knob or lever action and have variations for external and internal applications including privacy, keyed and non-keyed situations.



REBATED LATCH LOCKS

These are used when you have one door closing into another door, which is traditionally done on French Doors and Double Entry Doors. Rebated locks have a 13mm rebate in the face plate and strike and are available in Euro Lock, Skeleton Key Lock or you can use a Rebate Kit on a Tube Latch.



DEADBOLTS

Deadbolts are part of most other lock varieties and are the bolt that locks the door, designed in conjunction with latch or roller mechanisms that restrain the door but don't lock it. Deadbolts are also available as separate mortice or surface mounted units for supplementary security.



EASY FIT DEAD BOLTS

These are the simplest deadbolt to fix requiring two drilled holes and a surface mounted lock. They are available for single and double door applications.



SLIDING LOCKS

Sliding or Parrot's Beak Locks are locks with claw hooks to grab onto the opposing striker plate to secure a sliding door. They can have flat or half moon faces (known as astragal) and can be used internally or externally with either euro cylinder or skeleton key operation.



DEADLATCHES

These latches can be retracted by a key from either side or a knob or lever from the inside only. They can be either rim or mortice locks.



ELECTRONIC + KEYLESS LOCKS

Typically, these are a coded push button function that can be either mechanical (non-electric) or electronically wired into an intercom, remote or phone activated installation. When hard wired into a house, an electric strike is the simplest to install as it doesn't require wiring and power to be available in the door leaf. Battery powered digital options remotely accessible from smart phones are available but usually require regular charging to remain operational.



PART 3

hardware components

Woodworkers are door and window hardware specialists. This means we carry many products unique to our specialty that you won't find elsewhere. Many of these products we manufacture ourselves and others we buy in to ensure we offer you the widest range available. Our aim is to make outfitting timber joinery with attractive and coordinated hardware stress free and affordable.

woodworkers lever handles

lever handles



85cc

- 823S cottage on traditional plate euro
- 825S cottage on traditional plate privacy
- 824S cottage on traditional plate passage

no integral privacy option available for this handle.

48cc

- 827S cottage on slimline plate euro
- 828S cottage on slimline plate passage

no integral privacy option available for this handle.

48cc

- 829S heritage lever on plate euro
- 830S heritage lever on plate passage

no integral privacy option available for this handle.



85cc

- 833S soho lever on rose
- 834S berlin lever on square
- 844S milan lever on rose
- 832S zip lever on rose



85cc

- 823G cottage on traditional plate euro
- 825G cottage on traditional plate privacy
- 824G cottage on traditional plate passage

no integral privacy option available for this handle.

48cc

- 827G cottage on slimline plate euro
- 828G cottage on slimline plate passage

no integral privacy option available for this handle.



48cc

- 829G heritage lever on plate euro
- 830G heritage lever on plate passage

no integral privacy option available for this handle.

85cc

- 826G cottage lever on rose
- 834B berlin lever on square

all lever handles on rose can be used for entry, passage and privacy applications by adding a separate escutcheon and latch function

85cc

LEGEND
* = scale reduced

we're hands on with handles!



85cc

- 823B cottage on traditional plate euro
- 824B cottage on traditional plate passage

no integral privacy option available for this handle.

48cc

- 829B heritage lever on plate euro
- 830B heritage lever on plate passage

no integral privacy option available for this handle.

48cc

- 838B provence lever on plate euro
- 839B provence lever on plate passage
- 840B provence lever on plate privacy

48cc

- 835B chateau lever on plate euro
- 836B chateau lever on plate passage
- 837B chateau lever on plate privacy

refer to item code in current hardware pricelist for costings

woodworkers knobs + latch locks

85cc  **85cc** 

85cc  **85cc** 

826S cottage lever on rose
845S nida lever on rose
831ST clipper lever on rose
854S tokyo lever on rose

85cc 

842B baltimore lever on plate passage

841B baltimore lever on plate euro

48cc 

850B florence lever on plate euro

852B florence lever on plate privacy

851B florence lever on plate passage

48cc  **48cc** 

847G victorian knob on plate passage
847S victorian knob on plate passage

846G victorian knob on plate euro
846S victorian knob on plate euro

847AC victorian knob on plate passage

573 dummy spindle
for non operating levers and knobs

no integral privacy option available for these knobs.

LEGEND
48cc = 48mm
57cc = 57mm
85cc = 85mm

centre to centre between spindle and cylinder

all knobs on rose can be used for entry, passage and privacy applications by adding a separate escutcheon and latch function

821S victorian knob on rose
821G victorian knob on rose
821B victorian knob on rose
821AC victorian knob on rose

849TG timber knob on rose
843G reeded knob on rose

848WG porcelain knob on rose
843AC reeded knob on rose

single door euro latch locks

85cc  **85cc** 

104S 45mm back set latch lock
104G 45mm back set latch lock

105S 60mm back set latch lock
105G 60mm back set latch lock

1153S 45mm back set latch lock
1153G 45mm back set latch lock

1154S 60mm back set latch lock
1154G 60mm back set latch lock

138B 45mm back set latch lock
1153B 45mm back set latch lock

139B 60mm back set latch lock
1154B 60mm back set latch lock

Jackson 30mm back set latch lock
available in:
1177S silver
1177G gold
1177B black

138B 45mm back set latch lock
1153B 45mm back set latch lock
139B 60mm back set latch lock
1154B 60mm back set latch lock

double door rebated euro latch locks

85cc  **85cc** 

2104S 45mm back set rebated latch lock
2104G 45mm back set rebated latch lock

2105S 60mm back set rebated latch lock
2105G 60mm back set rebated latch lock

2153S 45mm back set rebated latch lock
2153G 45mm back set rebated latch lock

2154S 60mm back set rebated latch lock
2154G 60mm back set rebated latch lock

140B 45mm back set rebated latch lock
2153B 45mm back set rebated latch lock

141B 60mm back set rebated latch lock
2154B 60mm back set rebated latch lock

Jackson 30mm backset rebated latch lock
available in:
2177S silver
2177G gold
2177B black

knobs + latch locks

woodworkers latch + sliding + roller locks

sliding door hardware

skeleton key single latch locks



57cc

- 1180S 45mm backset latch lock
- 1181S 60mm backset latch lock



57cc

- 1180G 45mm backset latch lock
- 1181G 60mm backset latch lock

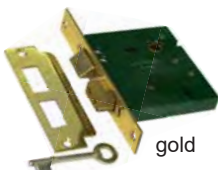

57cc

- 1180B 45mm backset latch lock
- 1181B 60mm backset latch lock



traditional 5 lever tumbler locks provide similar security to euro cylinder locks but cannot be master keyed.

skeleton key rebated latch locks

we've got the right lock for all situations.



- 2180S 45mm backset rebated latch lock

- 2181S 60mm backset rebated latch lock



- 2180G 45mm backset rebated latch lock

- 2181G 60mm backset rebated latch lock



- 2180B 45mm backset rebated latch lock

- 2181B 60mm backset rebated latch lock



sliding single door locks



- 126S flat sliding lock pictured 45mm backset

- 128S Jackson flat sliding lock 60mm backset



- 126G flat sliding lock pictured 45mm backset

- 128G Jackson flat sliding lock 60mm backset



example shows 126S lock with 583S flush pull + 862S 45mm cylinder

- 127B flat sliding lock 45mm backset

- 128B flat sliding lock 60mm backset



sliding double door astragal locks



- 129S astragal sliding lock pictured 53mm backset

- 131S Jackson astragal sliding lock 60mm backset



- 129G astragal sliding lock pictured 53mm backset

- 131G Jackson astragal sliding lock 60mm backset



- 130B astragal sliding lock 45mm backset

- 131B astragal sliding lock 60mm backset



skeleton key sliding locks

- 184S 45mm backset sliding lock

- 185S 60mm backset sliding lock



- 184G 45mm backset sliding lock

- 185G 60mm backset sliding lock



- 184B 45mm backset sliding lock

- 185B 60mm backset sliding lock

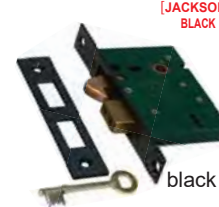

skeleton key astragal locks

- 186S 45mm backset astragal sliding lock

- 187S 60mm backset astragal sliding lock

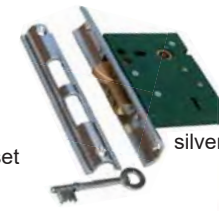

- 186G 45mm backset astragal sliding lock

- 187G 60mm backset astragal sliding lock



- 186B 45mm backset astragal sliding lock

- 187B 60mm backset astragal sliding lock

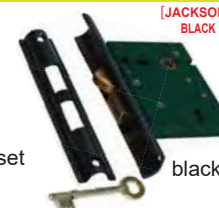

single door euro roller locks



- 106S 45mm back set roller lock

- 107S 60mm back set roller lock



- 106G 45mm back set roller lock

- 107G 60mm back set roller lock

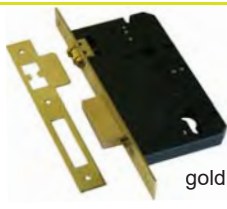

- 106B Tradco 45mm back set roller lock

- 107B 60mm back set roller lock pictured

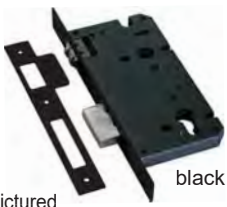

double door rebated roller locks

roller locks are ideal for use with presentation pull handles



- 2106S 45mm backset rebated roller lock

- 2107S 60mm backset rebated roller lock



- 2106G 45mm backset rebated roller lock

- 2107G 60mm backset rebated roller lock



- 2106B Tradco 45mm backset rebated roller lock

- 2107B 60mm backset rebated roller lock pictured

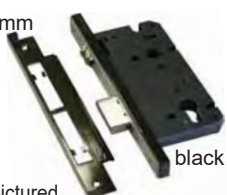

roller locks are key retractable and avoid the need for knobs or levers.

woodworkers locks + catches

easy fit cylinder levers

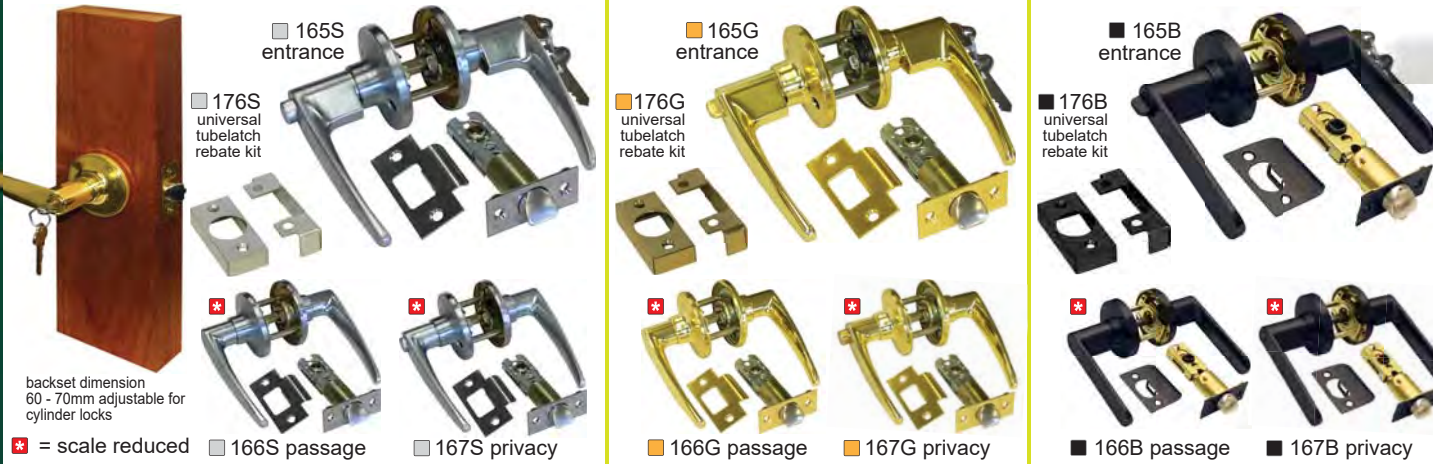

backset dimension 60 - 70mm adjustable for cylinder locks

* = scale reduced

- 165S entrance
- 165G entrance
- 165B entrance
- 176S universal tubelatch rebate kit
- 176G universal tubelatch rebate kit
- 176B universal tubelatch rebate kit
- 166S passage
- 166G passage
- 166B passage
- 167S privacy
- 167G privacy
- 167B privacy

easy fit cylinder knobs

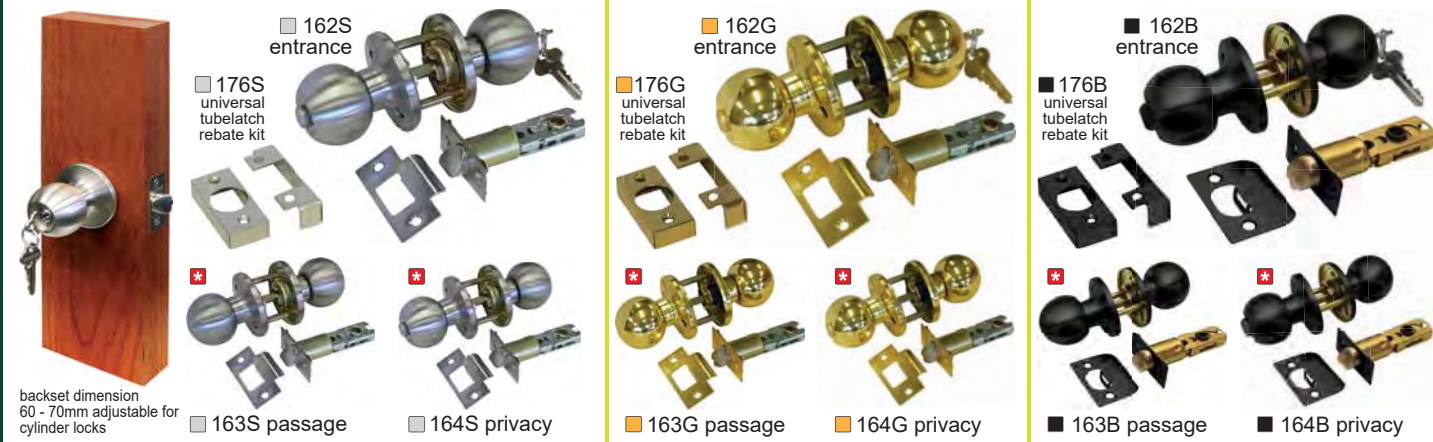

backset dimension 60 - 70mm adjustable for cylinder locks

* = scale reduced

- 162S entrance
- 162G entrance
- 162B entrance
- 176S universal tubelatch rebate kit
- 176G universal tubelatch rebate kit
- 176B universal tubelatch rebate kit
- 163S passage
- 163G passage
- 163B passage
- 164S privacy
- 164G privacy
- 164B privacy

easy fit dead bolts

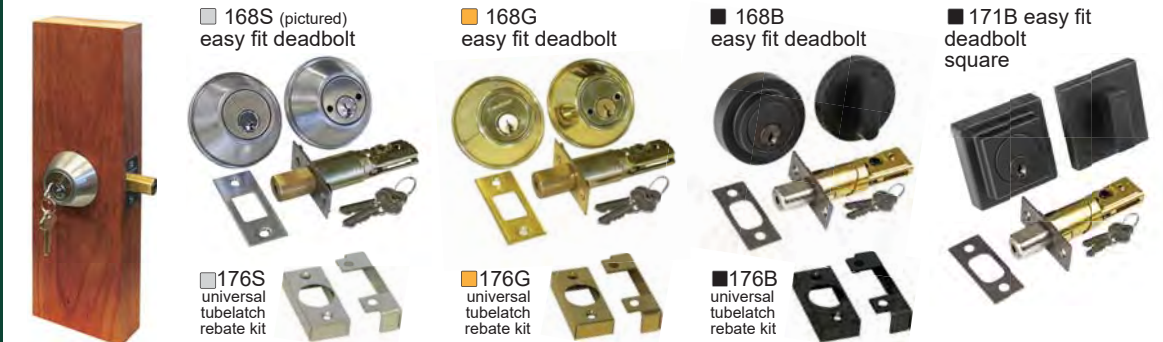

- 168S (pictured) easy fit deadbolt
- 168G easy fit deadbolt
- 168B easy fit deadbolt
- 171B easy fit deadbolt square
- 176S universal tubelatch rebate kit
- 176G universal tubelatch rebate kit
- 176B universal tubelatch rebate kit

viewers



- 566S adjustable door viewer 35 - 50mm
- 566G adjustable door viewer 35 - 50mm
- 566AC adjustable door viewer 35 - 50mm

single door mortice dead locks



we offer a Keyed alike service with all our euro locks

- 133S 45mm backset deadlock
- 134S 60mm backset deadlock
- 133G 45mm backset deadlock pictured
- 137G Jackson 60mm backset deadlock
- 136B Jackson 45mm backset deadlock
- 137B Jackson 60mm backset deadlock

silver

gold

black [JACKSON] BLACK

rebated mortice dead locks



door lock preparation & installation video

how to fit rebated door hardware video

- 2133S 45mm backset rebated deadlock
- 2134S 60mm backset rebated deadlock
- 2133G 45mm backset rebated deadlock pictured
- 175G Jackson 60mm backset rebated deadlock
- 174B Jackson 45mm backset rebated deadlock
- 175B Jackson 60mm backset rebated deadlock

silver

gold

black [JACKSON] BLACK

locks + catches

woodworkers door hardware

door hardware

rim locks

■ 853G 45mm milled edge knob
■ 822G 52mm milled edge knob
■ 853S 45mm milled edge knob
■ 822S 52mm milled edge knob
■ 142G rim lock 155 x 105mm
■ 142BG rim lock 155 x 105mm
■ 169G dead latch
■ 853B 45mm milled edge knob
■ 822B 52mm milled edge knob
■ 170G cylinder pull handle
■ 169S dead latch
■ 142B rim lock 155 x 105mm
■ 170S cylinder pull handle
■ 144AF/R right handed carpenters rim lock 182 x 128mm
■ 144AF/L left handed carpenters rim lock 182 x 128mm
■ 143AF/R right handed carpenters rim lock 150 x 120mm
■ 143AF/L left handed carpenters rim lock 150 x 120mm

left hand pictured
 traditional 144AF carpenters rim lock face fixed with 822G knob



extended strikes

48CC STRIKE TO SUIT 140MM FRAME
■ 114S universal
■ 114G/L left hand
■ 114G/R right hand

48CC STRIKE TO SUIT 160MM FRAME
■ 116S/L left hand
■ 116G/L left hand
■ 116G/R right hand
■ 116S/R right hand

85CC STRIKE TO SUIT 140MM FRAME
■ 118S universal
■ 118G universal

85CC STRIKE TO SUIT 160MM FRAME
■ 119S/L left hand
■ 119G/L left hand
■ 119S/R right hand
■ 119G/R right hand

JACKSON STRIKE TO SUIT 140MM FRAME
■ 120S universal handing
■ 120G universal handing
■ 120FB also available

JACKSON STRIKE TO SUIT 160MM FRAME
■ 121S universal handing
■ 121G universal handing

UNIVERSAL STRIKE TO SUIT 160MM FRAME
■ 122S universal handing
■ 122G universal handing

euro cylinders

what's so special about woodworkers **dual function** double euro cylinders?



Most insurance companies insist on a deadlock on all entries to a house. Conventional cylinders can only be operated from one side at a time however. If you leave a key in one side of the cylinder you can't open the lock from the other side so now you're locked out!

With a dual function cylinder however, keys operate from both sides independantly allowing the inside key to act as a temporary turnsnib for convenience. This turnsnib capability makes access easy when you're at home and can be quickly removed to comply with insurance deadlock requirements when you're out. Dual function euro cylinders are a great design innovation and are included in all Woodworkers hardware kits.

single cylinder
■ 860S 40mm
■ 860G 40mm
■ 862S 45mm
double cylinder
■ 862S 45mm
double cylinder dual function
■ 863S 65mm
■ 863G 65mm
■ 863B 65mm
■ 865S 80mm
■ 865G 80mm
■ 865B 80mm
■ 868S 90mm not dual function

single thumbturn cylinder
■ 861S 40mm
■ 861G 40mm

thumbturn double cylinders
■ 864S 65mm
■ 864G 65mm
■ 866S 80mm
■ 866G 80mm

privacy cylinders emergency release
■ 867S 60mm
■ 867G 60mm

energex cylinder
■ 869S 80mm

escutcheons

euro ■ 148S 55mm	euro ■ 146S screw on 53mm	euro ■ 147S push on 53mm	skeleton key ■ 172S rim lock	skeleton key ■ 149S jackson 45 x 19mm	euro ■ 150AS antique silver 49mm
euro ■ 152B pointed	euro ■ 146G screw on 53mm	euro ■ 147G push on 3mm	skeleton key ■ 172G rim lock	skeleton key ■ 149G jackson 45 x 19mm	euro ■ 151B scalloped
euro ■ 148B 60mm	euro ■ 146B screw on 53mm	euro ■ 147AC push on 53mm	skeleton key ■ 172B rim lock	skeleton key ■ 149B jackson 45 x 19mm	euro ■ 150B round 49mm

refer to item code in current hardware pricelist for costings

woodworkers door hardware

hinges



tubelatches



electronic + keyless locks



door hardware

woodworkers barrel + flush bolts

190mm door flush bolts

window flush bolts

barrel + flush bolts



605S 190mm non locking flush bolt
605G 190mm non locking flush bolt
605B 190mm non locking flush bolt

604S 190mm locking flush bolt
604G 190mm locking flush bolt
604B 190mm locking flush bolt

601S 190mm offset locking flush bolt
606G 190mm offset non locking flush bolt
601B 190mm offset locking flush bolt

623S 300mm offset locking flush bolt
623G 300mm offset locking flush bolt
622S 300mm straight locking flush bolt
622G 300mm straight locking flush bolt

603S 120mm offset locking flush bolt
602S 120mm locking flush bolt
602G 120mm locking flush bolt

621S dust proof strike
621G dust proof strike
624S masonry strike
624G masonry strike

620S 150mm reverse barrel bolt
620G 150mm reverse barrel bolt
620B 150mm reverse barrel bolt
620AC 150mm reverse barrel bolt
619S 100mm reverse barrel bolt
619G 100mm reverse barrel bolt

618S 150mm offset barrel bolt
618G 150mm offset barrel bolt
618B 150mm offset barrel bolt
617S 100mm offset barrel bolt
617G 100mm offset barrel bolt
617B 100mm offset barrel bolt
616S 75mm offset barrel bolt
616G 75mm offset barrel bolt
616B 75mm offset barrel bolt

Also available in Antique Copper in all these sizes

OFFSET BARREL BOLT
616AC - 75mm
617AC - 100mm
618AC - 150mm

STRAIGHT BARREL BOLT
613AC - 75mm
614AC - 100mm
615AC - 150mm

EXT. THROW BARREL BOLT
625AC - 150mm
refer to pricelist

611S 255mm concealed fix panic bolt
611G 255mm concealed fix panic bolt
611B 255mm concealed fix panic bolt

613S 75mm straight barrel bolt
613G 75mm straight barrel bolt
613B 75mm straight barrel bolt
614S 100mm straight barrel bolt
614G 100mm straight barrel bolt
614B 100mm straight barrel bolt
615S 150mm straight barrel bolt
615G 150mm straight barrel bolt
615B 150mm straight barrel bolt
625S 150mm extended throw barrel bolt
625G 150mm extended throw barrel bolt
625B 150mm extended throw barrel bolt
600S 500mm non locking flush bolt
600G 500mm non locking flush bolt
600B 500mm non locking flush bolt
612S 450mm concealed fix panic bolt
612G 450mm concealed fix panic bolt
612B 450mm concealed fix panic bolt

NOTE
other black tower and barrel bolt options are available in the gate hardware range.

refer to item code in current hardware pricelist for costings

woodworkers door accessories

router bits

DO NOT USE lever arch flush bolts



WARNING

Woodworkers does not sell or recommend lever arch flush bolts because they require a large concealed back swing which severs the tenons that hold the door together.

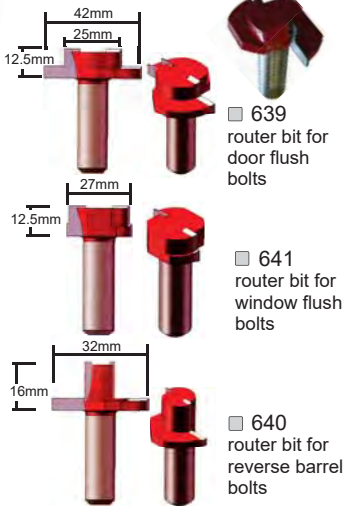

639 router bit for door flush bolts

641 router bit for window flush bolts

640 router bit for reverse barrel bolts

door stops + catches



588S door gripper catch total offset 85mm

588G door gripper catch total offset 85mm

539S half moon stop

539G half moon stop

539B half moon stop

578S concealed fix magnets 22mm diam

541G heavy duty roller catch

537S wall mount magnetic stop total offset 90mm

537G wall mount magnetic stop total offset 90mm

537B wall mount magnetic stop total offset 90mm

537AC wall mount magnetic stop total offset 90mm

586S bifold magnetic stop 40mm diam

586G bifold magnetic stop 40mm diam

541S heavy duty roller catch

538S floor mounted magnetic stop height 75mm

538G floor mount magnetic stop height 75mm

538B floor mount magnetic stop height 75mm

589G sparrows beak door catch total offset 85mm

587S toe operated door stop 140mm

587G toe operated door stop 140mm

540G light duty roller catch

540S light duty roller catch

536S suction door stop total offset 70mm

536G suction door stop total offset 70mm

589S sparrows beak door catch total offset 85mm

577G door guard

cabin hooks



535S silent pattern cabin hook 150mm

534S silent pattern cabin hook 100mm

535G silent pattern cabin hook 150mm

534G silent pattern cabin hook 100mm

535B silent pattern cabin hook 150mm

534B silent pattern cabin hook 100mm

535AC silent pattern cabin hook 150mm

534AC silent pattern cabin hook 100mm

594B traditional cabin hook 120mm

rack bolts



610G rack bolt

610S rack bolt

flush pulls

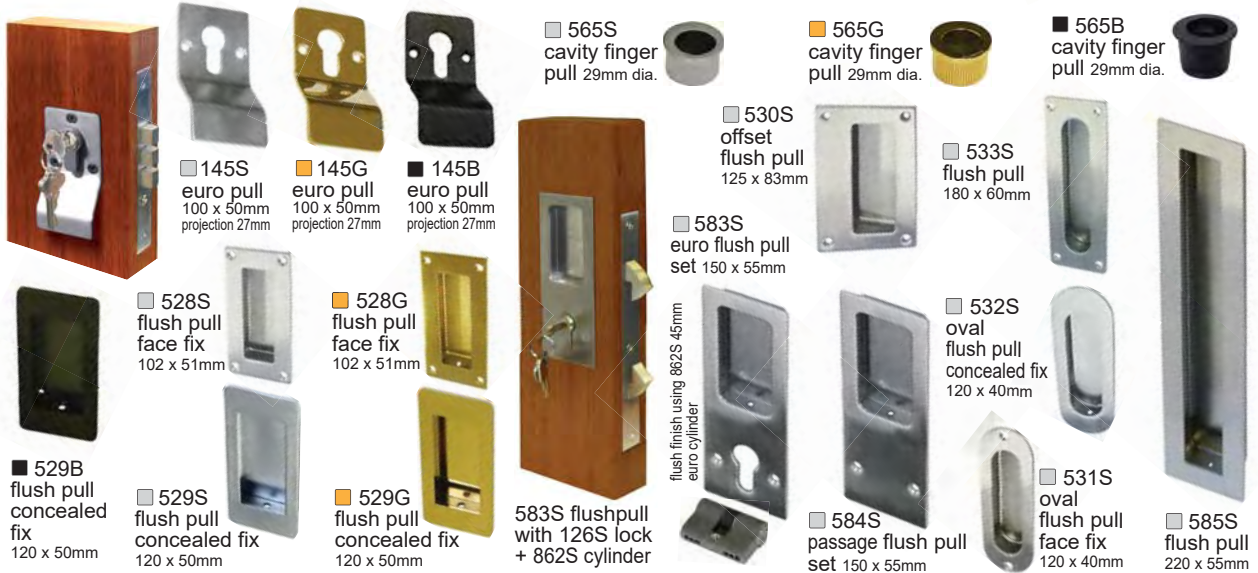

565S cavity finger pull 29mm dia.

565G cavity finger pull 29mm dia.

565B cavity finger pull 29mm dia.

145S euro pull 100 x 50mm projection 27mm

145G euro pull 100 x 50mm projection 27mm

145B euro pull 100 x 50mm projection 27mm

530S offset flush pull 125 x 83mm

533S flush pull 180 x 60mm

583S euro flush pull set 150 x 55mm

532S oval flush pull concealed fix 120 x 40mm

528S flush pull face fix 102 x 51mm

528G flush pull face fix 102 x 51mm

529G flush pull concealed fix 120 x 50mm

529B flush pull concealed fix 120 x 50mm

529S flush pull concealed fix 120 x 50mm

583S flushpull with 126S lock + 862S cylinder

584S passage flush pull set 150 x 55mm

531S oval flush pull face fix 120 x 40mm

585S flush pull 220 x 55mm

french door catches



598S french door square end fastener

500S french door teardrop fastener

598G french door square end fastener

500G french door teardrop fastener

598B french door square end fastener

500B french door teardrop fastener

500AC also available

refer to item code in current hardware pricelist for costings

woodworkers door accessories

door accessories

studs + door decorators

- 515B 30mm black pyramid
- 514B 25mm black pyramid
- 513B 22mm black pyramid
- 516B 20mm square stud
- 518S 23mm satin dome
- 513S 22mm satin pyramid
- 514S 25mm satin pyramid
- 515S 30mm satin pyramid

mock hinges + motifs

- 512B gothic mock hinge
- 511B Fleur de Lys mock hinge
- 950B speakeasy with hinged door o/a 178 x 115mm cutout 118 x 89mm
- 951B speakeasy grill o/a 292 x 343mm covers 200 x 250mm opening

domed sabu ss motif

- 895S/L 1000mm
- 895S/R 1000mm

domed jazz ss motif

- 897S/L 1000mm
- 897S/R 1000mm
- 898S/L 1300mm
- 898S/R 1300mm

flat sabu ss motif

- 892S/L 1000mm
- 892S/R 1000mm
- 893S/L 1317mm
- 893S/R 1317mm

- 559S seaport door decorator 540 x 121mm

- 558S newport door decorator 121 x 121mm

- 557S toku door decorator 46mm diam

we take the hard out of hardware



right handed pictured

right handed pictured

right handed pictured



laser cut flat stainless steel

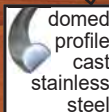

domed profile cast stainless steel

NOTE ss motif panels are available in left (L) and right (R) versions.

knobs + knockers

- 564B lions head knocker
- 569B chateau door knocker
- 509R rusty iron ring door knocker
- 507S granada door knocker
- 507G granada door knocker
- 507B granada door knocker
- 567S narrow door knocker
- 567G narrow door knocker
- 567B narrow door knocker
- 568S sienna door knocker
- 568G sienna door knocker
- 568B sienna door knocker
- 510G gold ring knocker

knobs & knockers are eye catching bling for your door!



centre pulls

- 505S victorian centre pull
- 506S granada centre pull C/F
- 505G victorian centre pull
- 506G granada centre pull C/F
- 504AF regent centre pull
- 506B granada centre pull C/F

bells

- 522G ships bell brass
- 522B ships bell black
- 570G batwing bell + turn

woodworkers gate hardware

pushes + pulls

563S large military flush pull 62 x 74mm
563G large military flush pull 62 x 74mm
562S medium military flush pull 52 x 64mm
562G medium military flush pull 52 x 64mm
561S small military flush pull 37 x 50mm
561G small military flush pull 37 x 50mm
560S extra small military flush pull 33 x 40mm
560G extra small military flush pull 33 x 40mm

580S flush ring turn 75mm
572B push plate 240 x 60mm
572G push plate 240 x 60mm
572S push plate 240 x 60mm

574S bow pull handle 150mm
574B bow pull handle 150mm
575G fleur de lys pull handle 165mm
575B fleur de lys pull handle 180mm
576B stradbroke handle 260mm

example of flush ring turn operating a latch lock

sliding door cavity units

502S polaris passage pull
501S polaris latch
590S square privacy latch
590B square privacy latch
591S long privacy latch
591G long privacy latch while stock lasts

example shows ironbark gate latch
 external view
 internal view

we've got hardware mates for your gates

gate hardware

926B rustic gate latch
913S dropbolt 300mm
914S dropbolt 450mm
938B ironbark gate latch
937B chateau gate latch
925B rustic slide bolt 400mm
923B rustic slide bolt 200mm
924B rustic slide bolt 300mm
919B gate D latch with flat strike
915S padbolt 110mm short throw
917S padbolt 150mm short throw
918S padbolt 150mm long throw
916S padbolt 110mm long throw
919S gate D latch with flat strike
920S D latch arm
921B gate D latch
935S hasp + staple galv 185 x 50mm

928S/L (left handed)
928S/R (right handed)
928B/L (left handed)
928B/R (right handed)

930S/L (left handed)
930S/R (right handed)

932G brass padlock o/a 35mm
931G brass padlock o/a 25mm

933S carbine padlock with 30mm shackle
934S carbine padlock with 50mm shackle

927S/L (left handed)
927S/R (right handed)

933S carbine padlock with 30mm shackle
934S carbine padlock with 50mm shackle

929S ball bearing gate hinges suits timber post + timber gate
929L (left handed)
929R (right handed)

930S ball bearing weld on gate hinges suits timber post + metal framed gate
930S/L (left handed)
930S/R (right handed)

931S heavy duty ball bearing strap hinge suits timber post + timber gate
931S/L (left handed)
931S/R (right handed)

932S ball bearing gate hinges suits timber post + timber gate
932S/L (left handed)
932S/R (right handed)

933S ball bearing gate hinges suits timber post + timber gate
933S/L (left handed)
933S/R (right handed)

934S ball bearing gate hinges suits timber post + timber gate
934S/L (left handed)
934S/R (right handed)

935S ball bearing gate hinges suits timber post + timber gate
935S/L (left handed)
935S/R (right handed)

609B tower bolt
608B wrought iron bolt
607B traditional bolt

gate hardware

woodworkers pivot + slider hardware

bottom roller sliding hardware

■ 7001 adjustable sliding bottom roller
■ 7000 black top track guide 25 x 25 x 3mm
■ 7003 sliding top glide 25 x 25 x 3mm
■ 7004 sliding bottom track 20 x 6.5mm
■ 7002 913DBA heavy duty double bogey adjustable roller
 BRIO TIMBEROLL 200 HEAVY DUTY BOTTOM ROLLER SLIDING DOORS
 • max height - 3000mm
 • max width - 3000mm
 • max weight - 200kg
 • door thickness - 38 - 48mm
 internal and external use.
 suitable for any number of doors to cover the opening on single or multiple tracks. doors may slide in one or both directions

NOTE : requires (2) two guides and (2) rollers per door. Top and bottom track comes in 5.8m lengths. Sold in 2,3,4 and 5.8m lengths only.

top hung sliding hardware

■ 7008 sold in 2, 3, 4 and 5.8m lengths
 BRIO SINGLE RUN 180 TOP HUNG HEAVY DUTY SLIDING DOORS
 • max height - 3000mm
 • max width - 2500mm
 • max weight - 180kg
 • door thickness - 35 - 48mm
 for internal and external use for ease of operation, suitable for a single door or for two doors on a bi-parting install doors may slide in one or both directions
door kit comprises
 • relevant length of top and bottom tracks
 • 2 hangers
 • 2 door stops
 • 2 guides

■ 7005 single track 250kg bracket
■ 7006 double track 250kg bracket
■ 7025 architrave guide
■ 7922S auto extending door seal
■ 7921 3 fin under door seal 920mm
■ 7920 3 fin under door seal 1200mm
■ 7926TB pivot brush seal
■ 7923BRW bifold z-seal
■ 7923W bifold z-seal
■ 7924BRW window block seal
■ 7924W window block seal
■ 7950 wall cavity sliding unit
■ 7925B undersash mohair strip

NOT PART OF THE KIT

■ 7008 bearing guide
■ 7008 47 x 48mm door bifold top track
■ 7008 door stop
■ 7008 top hanger
■ 7008 bifold door bottom polytrack 20 x 21mm
■ 7008 24 x 25mm aluminium sleeve for polytrack

pivots + closers

■ 7901S slimline parallel arm door closer
■ 7904S head reinforcing option for transom mounted hydraulic closer
■ 7905B narrow pivot arm option for 40mm doors
■ 7908S non hydraulic pivot bottom assembly
■ 7909 concealed spring action door closer 150mm
■ 7906 floor mounted pivot closer with cover plate and bottom arm
■ 7907S non hydraulic pivot top assembly
■ 7903 pivot door hydraulic transom closer
 also requires 7907S
 also requires 7907S

zero clearance top hung sliding hardware

■ 7040 sold in 2 and 3m lengths
 BRIO SINGLE RUN 100 ZERO CLEARANCE
 • max height - 3000mm
 • max width - 1500mm
 • max weight - 100kg
 • door thickness - min 35mm
 for internal use only suitable for a single door or multiple doors with a option of a soft close
door kit comprises
 • relevant length top track
 • 2 hangers
 • 2 clip stops
 • nylon saw cut guide

■ 7012 24 x 25mm aluminium sleeve for polytrack
■ 7013 bifold door bottom polytrack 20 x 21mm
■ 7022 bearing guide
■ 7027 soft close
■ 7025 architrave guide

NOT PART OF THE KIT

■ 7040 41 x 30mm 120 profile top track
■ 7040 hanger
■ 7040 saw cut guide
■ 7040 clip stop

light weight sliding hardware

■ 7009 sold in 2 and 3m lengths
 BRIO SINGLE RUN 60 PACK TOP HUNG SLIDING DOORS
 • max height : 2400mm
 • max width - 1500mm
 • max weight : 60kg/door
 • min door thickness - 24mm
 • internal use only
 suitable for a single door or for two doors on a bi-parting install doors may slide in one or both directions
door kit comprises
 • 2 hangers
 • 2 door stops
 • 1 guide
 • spanner + screws
 2m or 3m track lengths available

■ 7026 soft close
■ 7019 pelmet
■ 7007 bracket

NOT PART OF THE KIT

■ 7009 60 profile toptrack 31 x 30mm
■ 7009 door stops
■ 7009 spanner
■ 7009 saw cut guide
■ 7009 hanger

seals

■ 7920 3 fin under door seal 1200mm
■ 7921 3 fin under door seal 920mm
■ 7922S auto extending door seal
■ 7926TB pivot brush seal
■ 7923BRW bifold z-seal
■ 7923W bifold z-seal
■ 7924BRW window block seal
■ 7924W window block seal
■ 7950 wall cavity sliding unit
■ 7925B undersash mohair strip

seal extended
 seal retracted

woodworkers bifold hardware

barn door sliding hardware



Illustration shows Woodworkers stock barn doors



stainless steel kit components

black powdercoat kit components

OPEN RAIL SLIDING DOOR KITS

• max weight - 80kg • door thickness - 35 - 45mm

• internal use only • suitable for one or two doors to cover the opening on a single track • doors may slide in one or both directions

7015S 7015B see pricelist for other options

SINGLE DOOR KITS comprises
 • 2 hangers
 • 2 track stops
 • 1 bottom guide
 • 1 mounting bracket per 450mm of track
 • 2 end caps
 • 2 floor stops
 • 1 length of track

7016S 7016B see pricelist for other options

DOUBLE DOOR KITS comprises
 • 4 hangers
 • 4 track stops
 • 2 bottom guide
 • 1 mounting bracket per 450mm of track
 • 2 end caps
 • 2 floor stops
 • 1 length of track

internal bifolds

7010 sold in 2, 3, 4 and 6m lengths

BRIO SHUTTER FOLD 25 BIFOLD DOORS

• max height : 2400mm
 • max width : 900mm
 • max weight : 25kg/door
 • internal use only
 suitable for up to 6 leaves pivoted to each side of an opening available in
 • 2 door, 4 door + 6 door packs

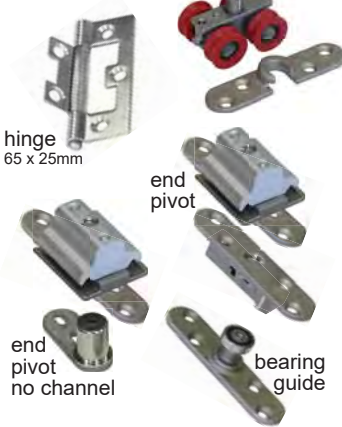

hinge 65 x 25mm

NOT PART OF THE KIT

7014 120 profile bifold door top track 31 x 41mm

7013 bifold door bottom polytrack 20 x 21mm

7012 24 x 25mm aluminium sleeve for polytrack

buy only the best bifold hardware and you'll never have any trouble



how to assemble & install a flat pack bifold kit video



door overhead track bifold hardware

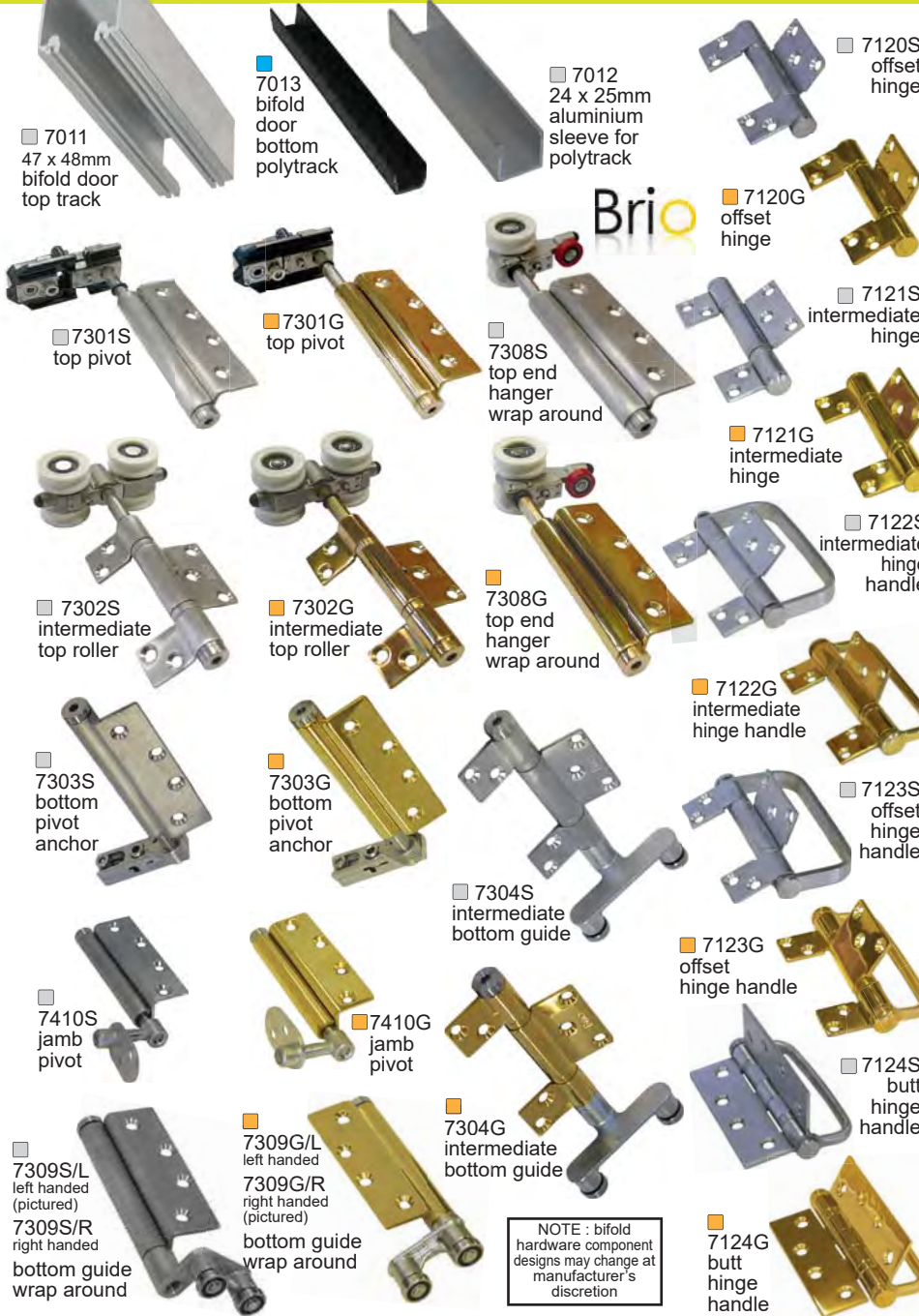

7011 47 x 48mm bifold door top track

7013 bifold door bottom polytrack

7012 24 x 25mm aluminium sleeve for polytrack

7301S top pivot

7301G top pivot

7308S top end hanger wrap around

7302S intermediate top roller

7302G intermediate top roller

7308G top end hanger wrap around

7303S bottom pivot anchor

7303G bottom pivot anchor

7304S intermediate bottom guide

7410S jamb pivot

7410G jamb pivot

7304G intermediate bottom guide

7309S/L left handed (pictured)
 7309S/R right handed

7309G/L left handed
 7309G/R right handed (pictured)
 bottom guide wrap around

7120S offset hinge

7120G offset hinge

7121S intermediate hinge

7121G intermediate hinge

7122S intermediate hinge handle

7122G intermediate hinge handle

7123S offset hinge handle

7123G offset hinge handle

7124S butt hinge handle

7124G butt hinge handle

NOTE: bifold hardware component designs may change at manufacturer's discretion

7401S see pricelist for other options
 BRIO 286 DUAL POINT LOCK SYSTEM

• panel thickness 38mm - 44mm
 • max panel height 2.9m
 • throw of bolt 25 x 5mm SS bar
 • 45mm backset
 • suits intermediate or end hanging doors
 • locking or non locking

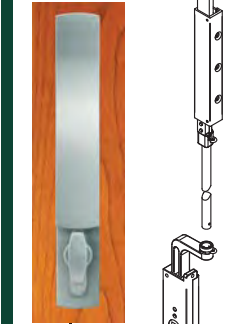

Suitable for internal locking only. External key entry options available. silver only

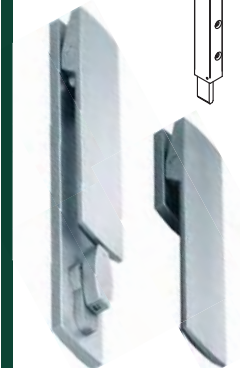

locking

non locking

bifold hardware

woodworkers window hardware

friction stays

stainless
3 bar
casement
or awning
friction stay

- 387S 203mm
- 329S 300mm
- 397S 305mm
- 388S 414mm
- 389S 503mm awning only
- 390S 602mm awning only

HEAVY DUTY

- 391S 263mm
- 392S 414mm
- 393S 567mm
- 394S 683mm awning only

how to install a casement sash video



whitco friction stays pair

- 395Z 200mm
- 396Z 300mm

* galv. zinc steel yellow finish (Z)

casement + shutter restraints

330B cable restrictor

330W cable restrictor

331B monkey tail casement stay 300mm

334G shutter "s" bracket to suit weatherboard

336S interlock safety restraint

304S casement bar stay 300mm

304G casement bar stay 300mm

304B casement bar stay 300mm

304AC casement bar stay 300mm

305S drop down telescopic stay (pictured)

306S screw down telescopic stay

305G drop down telescopic stay (pictured)

306G screw down telescopic stay

305AC drop down telescopic stay

306AC screw down telescopic stay (pictured)

305B black drop down telescopic stay available

fanlight hardware

312G fanlight catch

312S fanlight catch

312B fanlight catch

312S map rod

312B map rod

327S map rod

327G map rod

327B map rod

locking chain winders

Whitco

307S locking chain winder

307BRW locking chain winder

307B locking chain winder

307W locking chain winder

key lockable catches

316S locking casement lever universal

316G locking casement lever universal

316B locking casement lever universal

318W locking casement lever left hand

317W locking casement lever right hand

326AC locking teardrop casement fastener left hand

325AC locking teardrop casement fastener right hand

locking casement lever on side stile

locking casement lever on bottom rail

non-keyed catches

301S teardrop casement fastener

301B teardrop casement fastener

302S square end casement fastener

302B square end casement fastener

311S casement fastener

301G teardrop casement fastener

301AC teardrop casement fastener

302G square end casement fastener

332B monkey tail casement fastener

311G casement fastener

cockspurs

303S window spur catch

303G window spur catch

303B window spur catch

303AC window spur catch

335S window spur catch contemporary

handles

321S offset D pull handle

321G offset D pull handle

321W offset D pull handle

321B offset D pull handle

push locks

320S push lock

320B push lock

320W push lock

Whitco

341S hook hinge galvanised

313S fanlight cleat 75mm

313G fanlight cleat 75mm

313B fanlight cleat 75mm

314G fanlight pivot

314S fanlight pivot

314B fanlight pivot

window kits

fitch locks

- 322S keyed fitch lock
- 308S non keyed fitch fastener
- 322G keyed fitch lock
- 308G non keyed fitch fastener
- 322B keyed fitch lock
- 308AC non keyed fitch fastener
- 322W keyed fitch lock

our fitch fasteners have extended plates specific for timber double hung windows.

sash locks + holds

- 328S locking multi bolt
- 328G locking multi bolt
- 328B locking multi bolt
- 328W locking multi bolt
- 310S sash drop
- 310G sash drop
- 310AC sash drop
- 310B sash drop
- 333G sash screw

lifts

- 323S traditional sash lift
- 323G traditional sash lift
- 323B traditional sash lift
- 323W traditional sash lift
- 323AC traditional sash lift
- 309S contemporary sash lift
- 309B contemporary sash lift
- 309W contemporary sash lift

sliding window hardware

- 315S window flush pull 100 x 30mm
- 315G window flush pull 100 x 30mm
- 315W window flush pull 100 x 30mm
- 316B window flush pull 130 x 33mm
- 319S keyed window bolt
- 319G keyed window bolt
- 319W keyed window bolt
- 319B keyed window bolt

gas struts

Factory installed gas struts
For sizes up to 2.88m²
(max height 1500mm)
all other sizes POA

- 386B gas struts black
- 386S gas struts stainless steel

CASEMENT WINDOW KIT

CASEMENT & MULTIFOLD KITS

CASEMENT BOLT KIT
30. Keyed window bolt
31. Offset D-Handle

OR

CASEMENT & MULTIFOLD LEVER KIT
35. Keyed window lever - handed

CASEMENT WINDOW KIT - SILVER

- 4090S 30
- 31

BOLT KIT

CASEMENT WINDOW KIT - SILVER

- 316S (pictured) universal
- 35

LEVER KIT

CASEMENT WINDOW KIT - GOLD

- 4090G 30
- 31

BOLT KIT

CASEMENT WINDOW KIT - GOLD

- 316G (pictured) universal
- 35

LEVER KIT

CASEMENT WINDOW KIT - BLACK

- 4090B 30
- 31

BOLT KIT

CASEMENT WINDOW KIT - BLACK

- 316B (pictured) universal
- 35

LEVER KIT

CASEMENT WINDOW KIT - WHITE

- 4090W 30
- 31

BOLT KIT

CASEMENT WINDOW KIT - WHITE

- 317W (pictured) right handed
- 318W left handed
- 35

LEVER KIT

DOUBLE HUNG WINDOW KIT

DOUBLE HUNG WINDOW KIT

33. D/H keyed window lock
34. Sash lift x 2

DOUBLE HUNG WINDOW KIT - SILVER

- 4092S 34
- 33

DOUBLE HUNG WINDOW KIT - GOLD

- 4092G 34
- 33

DOUBLE HUNG WINDOW KIT - BLACK

- 4092B 34
- 33

DOUBLE HUNG WINDOW KIT - WHITE

- 4092W 34
- 33

HOPPER WINDOW KIT

HOPPER WINDOW KIT

35. Keyed window lever - handed

HOPPER WINDOW KIT - SILVER

- 316S (pictured) universal
- 35

HOPPER WINDOW KIT - GOLD

- 316G (pictured) universal
- 35

HOPPER WINDOW KIT - BLACK

- 316B (pictured) universal
- 35

HOPPER WINDOW KIT - WHITE

- 317W (pictured) right handed
- 318W left handed
- 35

SLIDING WINDOW KIT

SLIDING WINDOW KIT

30. Keyed window bolt
36. Window flush pull

SLIDING WINDOW KIT - SILVER

- 4093S 30
- 36

SLIDING WINDOW KIT - GOLD

- 4093G 30
- 36

SLIDING WINDOW KIT - BLACK

- 4093B 30
- 36

SLIDING WINDOW KIT - WHITE

- 4093W 30
- 36

woodworkers louvre galleries + accessories

louvre galleries

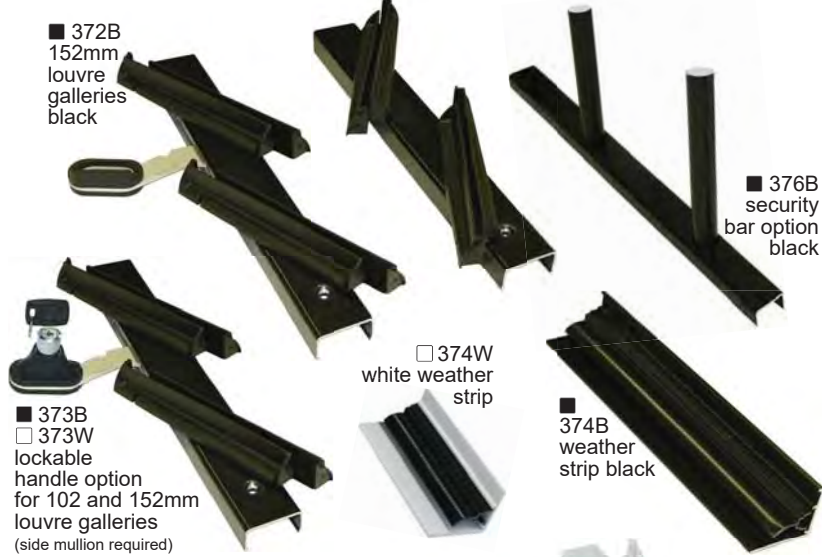

■ 372B
152mm
louvre
galleries
black

■ 376B
security
bar option
black

□ 374W
white weather
strip

■ 374B
weather
strip black

■ 373B
□ 373W
lockable
handle option
for 102 and 152mm
louvre galleries
(side mullion required)

■ 371B □ 371W
102mm adjustable
louvre galleries

number of blades	gallery height	handle quantity
3	292mm	1
4	381mm	1
5	470mm	1
6	559mm	1
7	648mm	1
8	737mm	2
9	826mm	2
10	914mm	2
11	1003mm	2
12	1092mm	2
13	1181mm	2
14	1270mm	2
15	1359mm	3
16	1448mm	3
17	1537mm	3
18	1626mm	3
19	1715mm	3
20	1803mm	3
21	1892mm	3
22	1981mm	4
23	2070mm	4
24	2159mm	4
25	2248mm	4
26	2337mm	4
27	2426mm	4
28	2515mm	4
29	2604mm	5
30	2693mm	5

■ 372B □ 372W
152mm adjustable
louvre galleries

number of blades	gallery height	handle quantity
2	305mm	1
3	445mm	1
4	584mm	1
5	724mm	1
6	864mm	1
7	1003mm	2
8	1143mm	2
9	1283mm	2
10	1422mm	2
11	1562mm	2
12	1702mm	2
13	1842mm	3
14	1981mm	3
15	2121mm	3
16	2261mm	3
17	2401mm	3
18	2540mm	3
19	2680mm	4
20	2820mm	4

□ 372W
white 152mm
louvre galleries

NOTES

- All controls are on the left hand gallery as standard. Right hand controls available to order.
- Maximum 7 blades per control on 102mm galleries and 6 blades on 152mm galleries.
- Key locking option available at additional cost.
- Glass louvre galleries take 152 x 6mm or 102 x 6mm polished edge glass blades.
- Timber louvre galleries are available that accept 102 x 13.5mm or 152 x 13.5mm profile timber blades.
- Standard colours are black, pearl white + silver anodised.

add 6mm to heights for weatherstrip

add 6mm to heights for weatherstrip

spirals + pulleys



spiral balances are only available in black tube.



removing & refitting spiral balances video



spiral number	body length	spiral number	body length
361 - 20	320mm	361 - 48	725mm
361 - 22	345mm	361 - 410	750mm
361 - 26	395mm	361 - 50	775mm
361 - 28	420mm	361 - 52	800mm
361 - 30	470mm	361 - 54	830mm
361 - 32	495mm	361 - 56	855mm
361 - 34	525mm	361 - 58	880mm
361 - 36	550mm	361 - 510	905mm
361 - 38	575mm	361 - 60	930mm
361 - 310	600mm	361 - 62	955mm
361 - 40	625mm	361 - 64	980mm
361 - 42	650mm	361 - 68	1030mm
361 - 44	675mm	361 - 70	1085mm
361 - 46	700mm	361 - 72	1110mm

Heavy duty Schlegel spiral balances are also available in white and black which are custom made for specific weights. They are POA and have extended lead times



■ 336G
sash pulley

342
sash weight
1kg, 8.5kg & 12.5kg

338
sash pulley cord

■ 340G
ball bearing sash pulley

■ 339G
sash pulley chain

■ 337S
counter weighted double pulley

glazing accessories



351
glass manifestation adhesive tape

358
glazing silicone for timber neutral cure 300g

other stuff



□ 344S
window hood privacy screen strut stainless steel 425mm

359
door lifter allows hands free adjustment of door height when fitting hinges

pet doors

DOG DOORS FOR INSTALLATION IN SOLID DOORS



colour: white only

345 **small**
flap size 175 x 240mm
dog shoulder height 230mm

346 **medium**
flap size 225 x 290mm
dog shoulder height 460mm

347 **large**
flap size 295 x 425mm
dog shoulder height 550mm

two way locking magnetic close



PET DOOR FOR INSTALLATION IN GLASS clear polycarbonate with weatherseal and 4 way locking system.

cat door

348
overall size: 280mm
flap size: 185 x 285mm
also suitable for small dogs

dog door

349
435mm
295 x 300mm
semi large dogs
430mm shoulder
(golden retriever)

vents



□ 350S
RETURN AIR VENT
aluminium 620 x 220mm
cutout size: 595 x 195mm
available in clear anodized and 16 powder coat colours
(quantity restrictions apply)

woodworkers stealshield + timber accessories



stealshield screens



top hinge detail

■ 377T timber grain d/hung top hinged stealshield



bottom pushlock detail

new product

stock stealshield panels for stock double hung windows available in timber grain and white.

height x width

- 2074 x 598
- 2074 x 758
- 1761 x 598
- 1761 x 898
- 1461 x 448
- 1461 x 598
- 1461 x 898
- 1161 x 448
- 1161 x 598
- 1161 x 898
- 1161 x 1198
- 961 x 598
- 961 x 898

■ 378T safebreeze

ventilation door panel with stealshield security mesh and openable clear glazed timbergrain sash aperture

sizes available

- 1048 x 224mm
- 1639 x 169mm

security isn't pricey... it's priceless



STEALSHIELD WINDOW PROTECTION

Stealshield panels provide affordable intruder, insect and bushfire protection and have the convenience of being easily openable for painting, cleaning and escape during emergencies. Stealshields are constructed of woven powdercoated stainless steel mesh with apertures less than 2mm to comply with bushfire regulations, encased in timber grain or white trim to blend unobtrusively with timber joinery.

□ 377W white double hung top hinged stealshield

insect screens



■ 380BZ bronze insect screen mesh



■ 381B black anodized aluminium insect screen mesh



■ 382B black fibreglass micro insect screen mesh



■ 383B black heavy duty pet proof pvc insect screen mesh

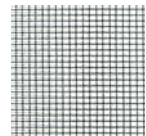

■ 384B black insect screen toggle 10mm offset



■ 384CL clear insect screen toggle 10mm offset



■ 379B black fibreglass insect screen mesh



■ 385T □ 385W

stock fibreglass mesh screens for d/hung windows. white + timber grain available

height x width	height x width	height x width
2057 x 713	1441 x 553	1141 x 403
2057 x 553	1441 x 403	941 x 853
1741 x 853	1141 x 1153	941 x 553
1741 x 553	1141 x 853	
1441 x 853	1141 x 553	

timber finials

RF2 RF3



70 x 70

ROOF FINIALS

650 mm
760 mm
950 mm

our turnery is made in durable hardwood customised designs available



Ball A
75 x 75



Acorn B
100 x 100



Crown 2
100 x 100



Crown 3
100 x 100

Stock timber balls for external use are made in durable hardwood



FP1
45 x 30



FP3
53 x 33



FP4
48 x 29



FP5
93 x 35



FP7
63 x 34



FP9
65 x 21

Stock timber small decorative finials turned from clear grade pine

timber corbels



hand carved corbels add character



T1
205 X 60 X 50



T2
245 X 60 X 60



T28
375 X 120 X 95



T5
200 X 60 X 45



T14
335 X 100 X 80



T16
320 X 100 X 75

Timber corbels are hand carved in Asian Cedar so may have slight variations

refer to item code in current hardware pricelist for costings

woodworkers finishes

woodworkers finishes



5 GOOD REASONS WHY YOU SHOULD USE SIKKENS OIL BASED COATINGS

- As a natural oil-based coating it nourishes the timber while at the same time allowing it to breathe.
- It is very easy to apply and can easily be removed from glass etc when accidents occur.
- It is equally easy to re-coat over time without the need for the complicated etching required with plastic acrylic coatings.
- It has excellent longevity
- It 'lubricates' movement of the joinery items that need to slide against each other (eg double hung windows) rather than acrylic coatings which tend to stick together.

SIKKENS ON CEDAR

077 pine



006 light oak

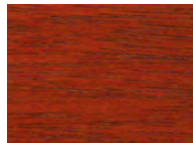

009 dark oak



010 walnut*



045 mahogany



048 rosewood

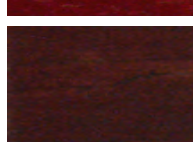

085 teak

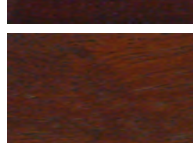

813 silver grey



020 ebony*

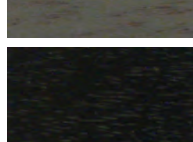

SIKKENS ON PINE

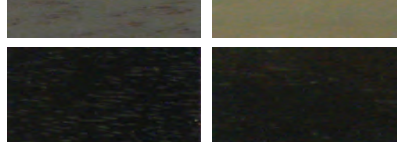
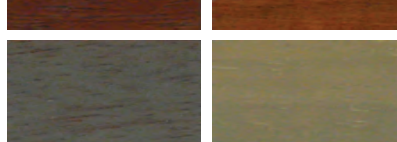
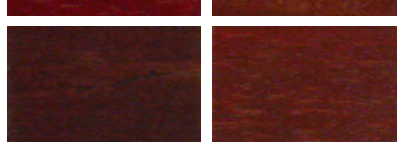
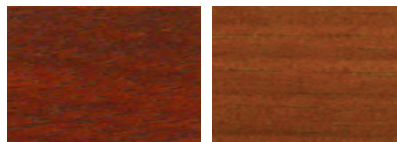
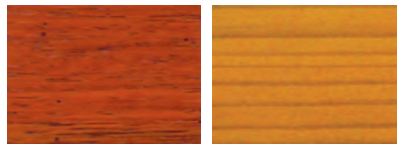

finishing products

sikkens



362 CETOL HLS
Water repellent, penetrating, low build transparent wood stain used as a base coat under cetol Filter 7 Plus, TGL Gloss Plus and Deck Plus.
1L, 5L + 20L cans



366 CETOL TGL PLUS
High gloss oil based finish for exterior doors applied over Cetol HLS base coat. Durable, flexible and completely clear
1L + 5L cans



363 CETOL FILTER 7 PLUS
Flexible medium build transparent satin top coat with UV filters. Designed as two coat finishing over Cetol HLS.
1L, 5L + 20L cans



368 WHITE UNDERCOAT FAST DRYING
Quick drying oil based undercoat that sands to a smooth base for enamel top coats
1L, 2L, 4L + 10L cans



364 CETOL DECK
Water repellent wear resistant durable high build transparent coating applied over Cetol HLS primer.
1L, 5L + 20L cans



370 CEDAR SEAL
Water repellent, penetrating, low build transparent wood stain used as a base coat under cetol Filter 7 Plus, TGL Gloss Plus and Deck Plus.
1L, 5L + 20L cans



365 CETOL TSI SATIN PLUS
Transparent oil based finish for interior use only. Non toxic with good resistance to wear. Seal, top coat and stain in a single can.
1L + 2.5L cans



369 TIMBER MATE WOOD FILLER
Interior grade non shrinking water soluble filler
250g + 500g tubs



how to finish your joinery video

we recommend these products because we know they work!



352 INOX
stainless steel lubricant spray
100gm +300gm

* Dark colours are not recommended for external use. Refer FAQ 3 for warranty conditions

woodworkers videos

product videos



entry doors



windows



bifolds french doors and sliders



shutters and blinds

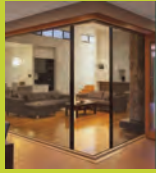

video brio pleated insect screens



restoration products



discounted excess stock



offshore joinery manufacture



repairing dints and finishing timber

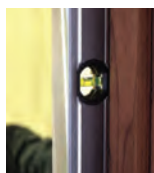

how to install a timber frame



door lock preparation & installation



how to fit rebated door hardware



video how to assemble & install a flat pack bifold kit



adjusting a top hung brio bifold



video restringing a brio insect screen



how to measure for plantation shutters



adjusting and weather sealing a pivot door

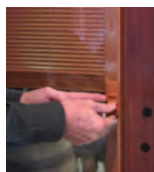

reconnect a vista control



how to install a casement sash



removing & refitting spiral balances



installing a window hood & privacy screen



how to measure & install balustrade



Woodworkers have produced numerous videos aimed at explaining our products and providing practical instructions on common issues relating to their installation and maintenance. Our video range continues to expand and augments our extensive website FAQ section which focuses on product details and consumer queries. To access the videos you would need to have downloaded the QR code scanner application for your mobile device.

woodworkers videos

'how to' videos

Need more information or prices refer our FAQ sheets at www.woodworkers.com.au or entering WOODWORKERS COMPANY on for our 'how to' videos

Our website FAQ sheets explain most issues that relate to our products & provide current pricing.

